



# POLARIS SPORTSMAN

2023

ACCESSORIES,  
GARAGE & APPAREL

INTERNATIONAL VERSION



# FORGE YOUR OWN PATH



The ATV that defined the industry, Sportsman combines legendary smoothness, unstoppable versatility and an ease of use that the competition continues to chase, which is why Sportsman is chosen by more ATV owners. Whether you're tearing up the trails, working out in the fields, or navigating the wilderness for the perfect hunt, there is a Sportsman story to be told.

## LINEUP

450 / 570

P. 12

### RECREATION & UTILITY



SPORTSMAN 450 H.O.  
(EPS, UTILITY)



SPORTSMAN 570  
(EPS, PREMIUM, TRAIL)

### TOURING



SPORTSMAN TOURING 570  
(EPS, PREMIUM)

### WORK



SPORTSMAN  
570 6x6

850 / XP 1000 / XP 1000 S

P. 22

### RECREATION & UTILITY



SPORTSMAN 850  
(PREMIUM, ULTIMATE TRAIL)



SPORTSMAN XP 1000  
ULTIMATE TRAIL

### TOURING



SPORTSMAN  
TOURING 850



SPORTSMAN TOURING  
XP 1000 TRAIL

SCRAMBLER 850 / XP 1000 S

P. 30

### SPORT PERFORMANCE



SCRAMBLER 850



SCRAMBLER XP 1000 S



SPORTSMAN XP 1000 S

YOUTH

P. 32



OUTLAW 70 EFI

## CONTENTS

CONNECTED TECHNOLOGY 6

WINCHES 10

450 / 570 12

WINCHES, PROTECTION & RACKS ..... 14

COMFORT, AUDIO & STORAGE ..... 16

WINDSHIELDS ..... 18

570 6X6, 570 TOURING & 570 X2 ..... 20

850 / XP 1000 / XP 1000 S 22

WINCHES, RACKS & PROTECTION ..... 24

STORAGE, AUDIO & COMFORT ..... 26

WINDSHIELDS ..... 28

SCRAMBLER 850 / XP 1000 S 30

YOUTH 32

COMMON ACCESSORIES 34

GLACIER PLOW SYSTEMS ..... 34

TRACKS ..... 36

WHEELS & TIRES ..... 38

LIGHTING ..... 44

HUNT ..... 46

POLARIS NORTHSTAR COOLERS ..... 48

PARTS & GARAGE 50

MAINTENANCE ..... 50

OIL & LUBRICANTS ..... 52

MAINTENANCE FLUIDS ..... 54

GARAGE ACCESSORIES & BATTERY CHARGERS 56

HO PARTS ..... 58

SERVICE PARTS ..... 60

TIRE SEALANT & TRAILERING ..... 62

POLARIS POWER ..... 64

APPAREL 70

JERSEYS & GLOVES & HEATED APPAREL ..... 72

HELMETS & GOGGLES ..... 74

MEN'S APPAREL ..... 76

BALL CAPS ..... 80

CAMO APPAREL ..... 81

WOMEN'S APPAREL ..... 82

HOME & COLLECTIBLES ..... 84



**DESIGNED**

by the people who designed your vehicle.



**TESTED**

extensively in the field so you ride with 100% confidence.

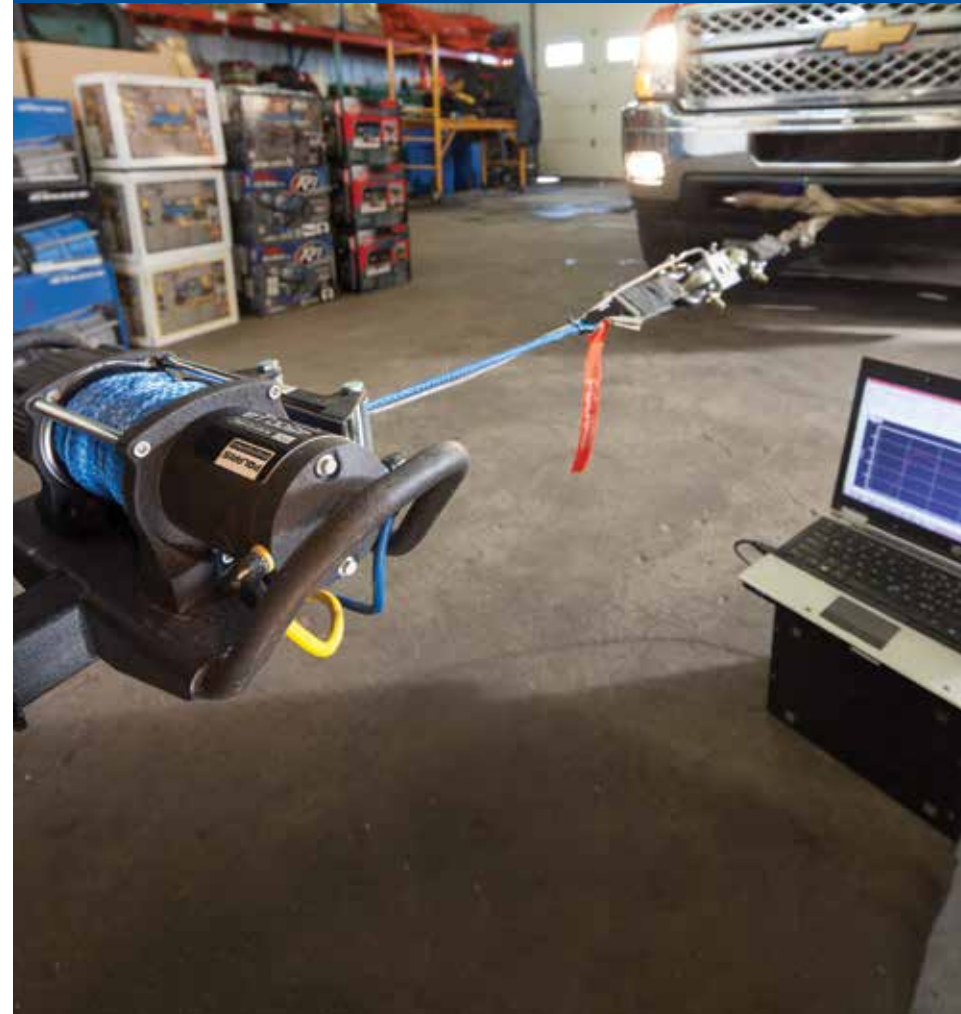

**TRUSTED**

65 years in the business.  
The #1 name in Off-Road.



**WE HOLD OUR PARTNERS  
TO THE SAME STANDARDS**



WHEELS, TIRES & LIGHTING DESIGNED  
WITH POLARIS TO MAXIMIZE PERFORMANCE  
P. 38, 45



A GLOBAL LEADER IN AUDIO INNOVATION,  
DESIGN & ENGINEERING  
P. 17, 27



PRODUCTS SO GOOD THEY REPLACE  
OR REPAIR THEM FOR LIFE  
P. 44



MAKING PRODUCTS FOR  
AVID SPORTSMEN SINCE 1943  
P. 46



# ENGINEERED FOR MORE

Ensuring Polaris Engineered Accessories fit and work in sync with your machine is the most critical phase of testing and validation. With seamless integration, you can trust that any Polaris accessory you install will enhance your interaction beyond your expectations.



## LOCK & RIDE®

### CARGO VERSATILITY

Lock & Ride mounting locations allow for limitless customization to let you work the way you want.

P.17,26

## POLARIS RIDECOMMAND

### PLAN. TRACK. SHARE. CONNECT.

Ride in confidence with industry-exclusive technology showing the way on the Polaris app powered by RIDE COMMAND.

P.6



## PRO PRO HEAVY DUTY SERIES

# WINCHES

### INTEGRATED WINCH MOUNT & PRE-WIRED

Designated mounting points and pre-wired contactors ensure a perfect fit and the strongest place to attach the Polaris Engineered winch - the most dependable winch for your Sportsman. With wiring built right into the vehicle, we made this the easiest Sportsman winch ever made to install.

P.10

## GLACIER® PLOW SYSTEM

### INTEGRATED PLOW MOUNT

The attachment points for the Glacier Plow System are integrated right at the factory and feature an innovative drive-up and go installation process.

P.34



# CONNECTED TECHNOLOGY

## ENHANCE YOUR RIDE.



	POLARIS RIDE COMMAND	POLARIS RIDE COMMAND+
VEHICLE OWNERSHIP	GARAGE	✓
	MAINTENANCE TRACKING	✓
	ISSUE DIAGNOSTIC	✓
RIDING FEATURES	VEHICLE HEALTH	✓
	COMMUNITY	✓
	CONTENT SHARING	✓
	RIDE PLANNING	✓
	WAYPOINTS	✓
	RIDE TRACKING	✓
	RIDE TRACKING+	✓
SECURITY	GROUP RIDE	✓
	GROUP RIDE+	✓
	VEHICLE LOCATOR	✓
	LOCATION ALERTS	✓
	BUMP ALERT	✓

## POLARIS RIDE COMMAND

### PLAN YOUR RIDE

Plan an epic ride with stops along the way, customize and adjust your path to maximize your route or follow turn-by-turn directions. You can even share your planned route with friends.

### FOLLOW THE GROUP

With Group Ride, you can ride at your own speed and keep fellow riders in sight on your map screen, even if you get split up. Because rides are meant to be shared.

### WORK SMARTER

Plow Mode automatically raises and lowers the plow depending on the gear you're in, so that you can get your work done quicker.

### DISCOVER NEW TRAILS

With over 1,000,000 miles of trails available offline, you'll have the confidence to explore further, whether you have cellular coverage or not.

## INTRODUCING POLARIS RIDE COMMAND+

### THE LATEST IN INDUSTRY-LEADING CELLULAR TECHNOLOGY CONNECTING YOU TO YOUR VEHICLE

Vehicle location and health in the palm of your hand. Over the air updates with new feature releases.

AVAILABLE ON RIDE COMMAND EDITION MODELS & AS AN ACCESSORY

#### 7" DISPLAY POWERED BY RIDE COMMAND\*

- **Bright, 7" touchscreen** visible in all conditions.
- **Configurable Gauges** Customize your ride experience with elevation, travel direction, fuel level and more to create relevant screens for you.
- **Personalized Audio Experience** Seamlessly pair your display via Bluetooth to wirelessly stream music and stay connected with call and text alerts. Add the Lock & Ride Rear Audio Storage Box to stream music. (Requires Lock & Ride Rear Audio Storage Box and Rear Power Harness.)
- **Industry's Only Plow Mode** Quick and easy plowing. Plow automatically lowers when shifted into low gear and raises when shifted into reverse. (Requires Polaris Winch with Auto Stop Technology and Synthetic Rope. Learn more on P. 10.)
- **7" Display Mount Kit Included** Comes with required wiring harnesses and accessory components. Includes V2V and GPS antenna.

\* 2889455  
SPORTSMAN 450/570 '22-'23, SPORTSMAN 850/1000 '22-'23

**NEW**

AVAILABLE ON SELECT 2023 MODELS  
**PLUG-IN\*\***

- **Vehicle Locator** Pinpoint exactly where your vehicle is at any time, on or off your property. Using the Polaris App powered by RIDE COMMAND, the vehicle locator gives you the peace of mind that you will be able to get back your ride.
- **Vehicle Health** Before you head out, log in using the Polaris App to remotely check on the readiness of your ride for the day you have planned. Monitor gas or battery condition, estimated range and oil change status for a confident start to the day.
- **Bump Alert Coming Soon!** Protect your investment by keeping tabs on it 24/7. Receive a notification if your vehicle has been bumped or moved from its last location and track.
- **Ride Tracking+ Coming Soon!** Map the details of your entire ride automatically including route, average speed, time elapsed, elevation changes and more. You can even save tracked rides and go back to your favorite spots or share with your friends.

» **PLUG-IN • 2890038**  
SPORTSMAN 450/570 '23,  
SPORTSMAN 850/1000 '23,  
SPORTSMAN XP1000 '23

» **INSTALL KIT • 2889534**  
SPORTSMAN 570 RIDE COMMAND EDITION '23,  
SPORTSMAN 570 UTILITY HD '23, SPORTSMAN 570  
EPS '23, SPORTSMAN 570 PREMIUM EPS '23,  
SPORTSMAN 570 TRAIL '23  
REQUIRED IN ADDITION TO 2890038

» **INSTALL KIT • 2889535**  
SPORTSMAN XP1000 '23, SPORTSMAN 850 '23  
REQUIRED IN ADDITION TO 2890038

» **INSTALL KIT • 2889615**  
SPORTSMAN 450/570 '23  
REQUIRED IN ADDITION TO 2890038

\*Due to ongoing supply chain issues, there may be delayed or limited availability of this product as an accessory add-on.

\*\*Check with your local dealer for availability.



# SUPERIOR INTEGRATION

**POLARIS**  
**ENGINEERED**

Right from the factory, your vehicle is built to make essential accessories like winches and plows easy to use day-in and day-out. Mounting brackets are designed into the oversized factory bumper and wiring is routed securely and properly. When it comes to Sportsman, Polaris Engineered Accessories make work easier so you can get more done.

## POLARIS ENGINEERED WINCHES

- ✓ Tested 1,200+ pulls at max load, it works when you need it to
- ✓ Built for winter, withstands -29° C temperatures
- ✓ Pre-wired chassis  
Factory-installed wiring makes the controls simple to install. Mount the winch, connect the wires and trust that everything is routed safely, securely, and properly.
- ✓ No need to cut panels
- ✓ Sealed motor and heavy-duty gears operate fully submerged underwater
- ✓ Military tested and approved

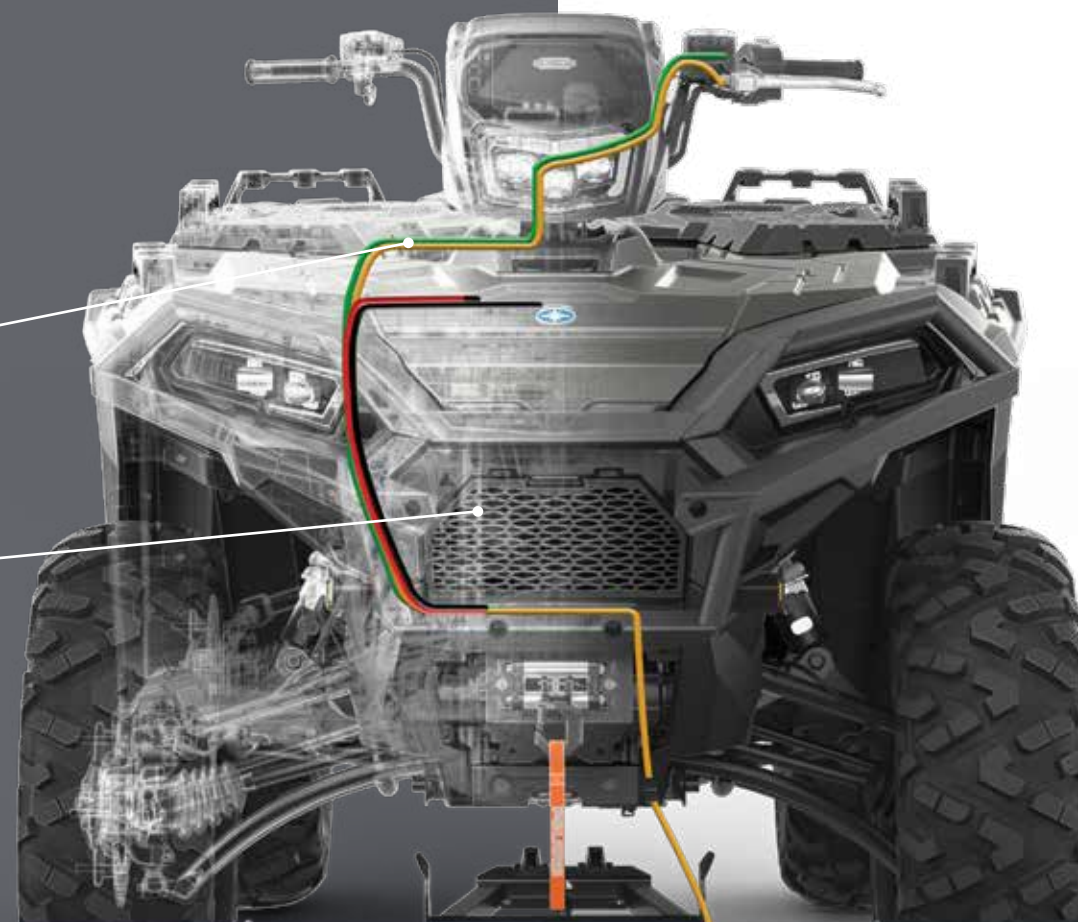

## GLACIER PLOW SYSTEM

- ✓ Easily engage and disengage the plow system from your Sportsman
- ✓ No loss of factory ground clearance when not plowing
- ✓ Don't have to crawl under the machine to release the plow blade from the vehicle
- ✓ No trimming of vehicle plastic required to mount plow or winch

LEARN MORE ABOUT  
POLARIS ENGINEERED WINCHES  
SEE P. 10

LEARN MORE ABOUT THE  
GLACIER PLOW SYSTEM  
SEE P. 34





# WINCHES



**ADD A PLOW**  
P. 34

## DEPENDABLE. TOUGH. BUILT FOR THE OFF-ROAD.

A Polaris Engineered winch is designed to help you get the job done right, get you on your way faster and prepare you for the unexpected.

### WHY POLARIS?

Polaris off-road vehicles are engineered with designated mounting points and wiring for seamless install of Polaris Engineered winches.



TESTED **1,200+** PULLS AT MAX LOAD



BUILT TO WITHSTAND **-29° C** TEMPERATURES



OPERATES FULLY SUBMERGED



MILITARY TESTED & APPROVED

## REPLACEMENT PART



### REPLACEMENT STEEL CABLE

- 1588 kg winch series - 15.2 m
- » 2878890



### RECOVERY STRAP

- 5cm x 9.1 m (8165 kg)
- Comes with carry bag
- » 2884033

## FEATURES & BENEFITS

### ALL POLARIS ENGINEERED WINCHES COME WITH:

- ✓ INTEGRATED WIRING, MOUNT, PREASSEMBLED
- ✓ HOOK WITH STRAP
- ✓ CUT STEEL GEARS & SEALED DRIVETRAIN
- ✓ SEALED PERMANENT MAGNET MOTOR



Retrieve cable 5x as fast as standard mode on other Polaris winches. Get back to riding or complete your task quicker.

1. Set winch dial to N (Neutral) to manually pull the rope out and secure the hook to your anchor point
2. Set winch dial to L (Low) for maximum pulling power while winching your load
3. Set winch dial to H (High) for retrieving the rope 5x faster with Rapid Rope Recovery

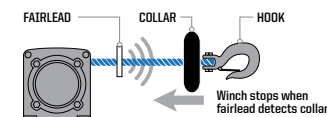

Auto Stop technology protects and extends the life of your winch by automatically stopping the winch at the end of pull to prevent over-spooling. While plowing, it prevents the plow frame from bending by stopping the winch once the plow has been lifted.



With its lightweight, yet extremely strong, design and superior flexibility, this 15.2 m long synthetic rope is easy to handle and can stand up to any tough job.



This convenient remote operates your Polaris winch wirelessly from within 15.2 m of the vehicle. Operate your winch safely outside your vehicle while on the job site or trails.

### MODEL

**450 H.O.** '21-23  
**570** '21-23

**450 H.O.** '16-20  
**570** '14-20  
**X2 570** '15-21  
**TOURING 570** '14-21  
**6X6 570** '17-21

**850** '12-23  
**XP 1000** '15-23  
**TOURING XP 1000** '15-23  
**TOURING 850** '15-23  
**SCRAMBLER 850** '14-23

**SPORTSMAN XP 1000 S** '20-23  
**SCRAMBLER XP 1000 S** '20-23

**PRO** PRO HEAVY DUTY SERIES

## TOP-OF-THE-LINE FEATURES

BEST FOR PLOWING, HEAVY-DUTY OUTDOOR CHORES & TRAIL RIDING



**PRO** PRO HEAVY DUTY SERIES

**HD** HEAVY DUTY SERIES

## BUILT FOR THE OFF-ROAD

BEST FOR THE CASUAL OFF-ROAD RIDER



**HD** HEAVY DUTY SERIES



NOT AVAILABLE



### ADD AUTO STOP TECHNOLOGY



**2881693**  
SYNTHETIC ROPE REQUIRED  
FITS WINCHES: 2880434, 2880432



**2889253**  
SYNTHETIC ROPE REQUIRED  
FITS WINCHES: 2884832, 2884833, 2889469, 2889470



**TOP SELLER**  
ADD SYNTHETIC ROPE  
**2878888**



### ADD WIRELESS WINCH REMOTE

**2879316**

**1588 kg**  
with Synthetic Rope

**TOP SELLER**  
**2884834**

**1588 kg**  
with Synthetic Rope

**TOP SELLER**  
**2884833**

**TOP SELLER**  
**2880434**

**1134 kg**  
with Steel Cable

**TOP SELLER**  
**2884832**

**TOP SELLER**  
**2880432**

**2889471**

**2889470**

**2889469**

**2883580**



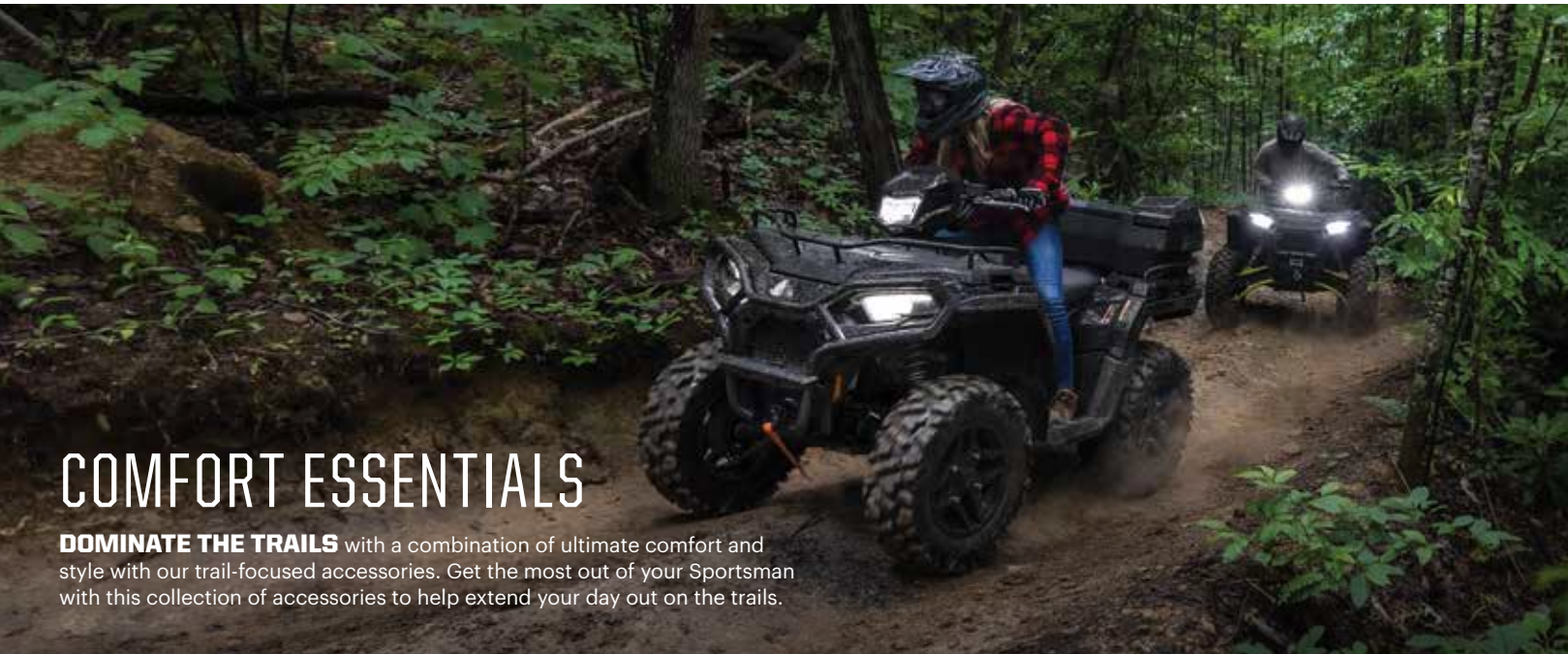

## COMFORT ESSENTIALS

**DOMINATE THE TRAILS** with a combination of ultimate comfort and style with our trail-focused accessories. Get the most out of your Sportsman with this collection of accessories to help extend your day out on the trails.

Polaris Pro HD 1,588 kg Winch	P. 14	LED Light Kit	P. 16	Pro Armor Wheel & Tire Set: Dual Threat/4202	P. 43
Trail Brushguard	P. 14	Rear Power Harness	P. 16	Lug Nuts	P. 43
Rear Brushguard	P. 14	<b>LOCK &amp; RIDE</b> Rear Audio Storage Box	P. 17	RIGID D-Series Pro Driving LED Light	P. 44
Rear Rack Extender	P. 15	Audio Storage Box Remote	P. 17	Lightbar Harness	P. 45
Handguards	P. 16	Pod Bag	P. 17	LED Y-Harness	P. 45
Handguard Mount	P. 16	Fender Bag	P. 17		



Polaris HD 1,588 kg Winch	P. 14	<b>LOCK &amp; RIDE</b> Tall Windshield	P. 18	Lightbar Harness	P. 45
HD Front Brushguard with Hitch	P. 14	Pro Armor Wheel & Tire Set: Mud XC/4205	P. 43	Gun Boot L	P. 46
Rear Rack Extender	P. 15	Lug Nuts	P. 43	Stronghold Auto-Latch Mount	P. 46
Hand & Thumb Warmer Kit	P. 16	RIGID SR-Series 25.4 cm Combo LED Light	P. 45	<b>LOCK &amp; RIDE</b> Rhino Grip Pro	P. 47

**WORK HARD AND GET IT DONE** with Polaris Engineered Accessories. Find everything you need to outfit your trusted partner for the task at hand.

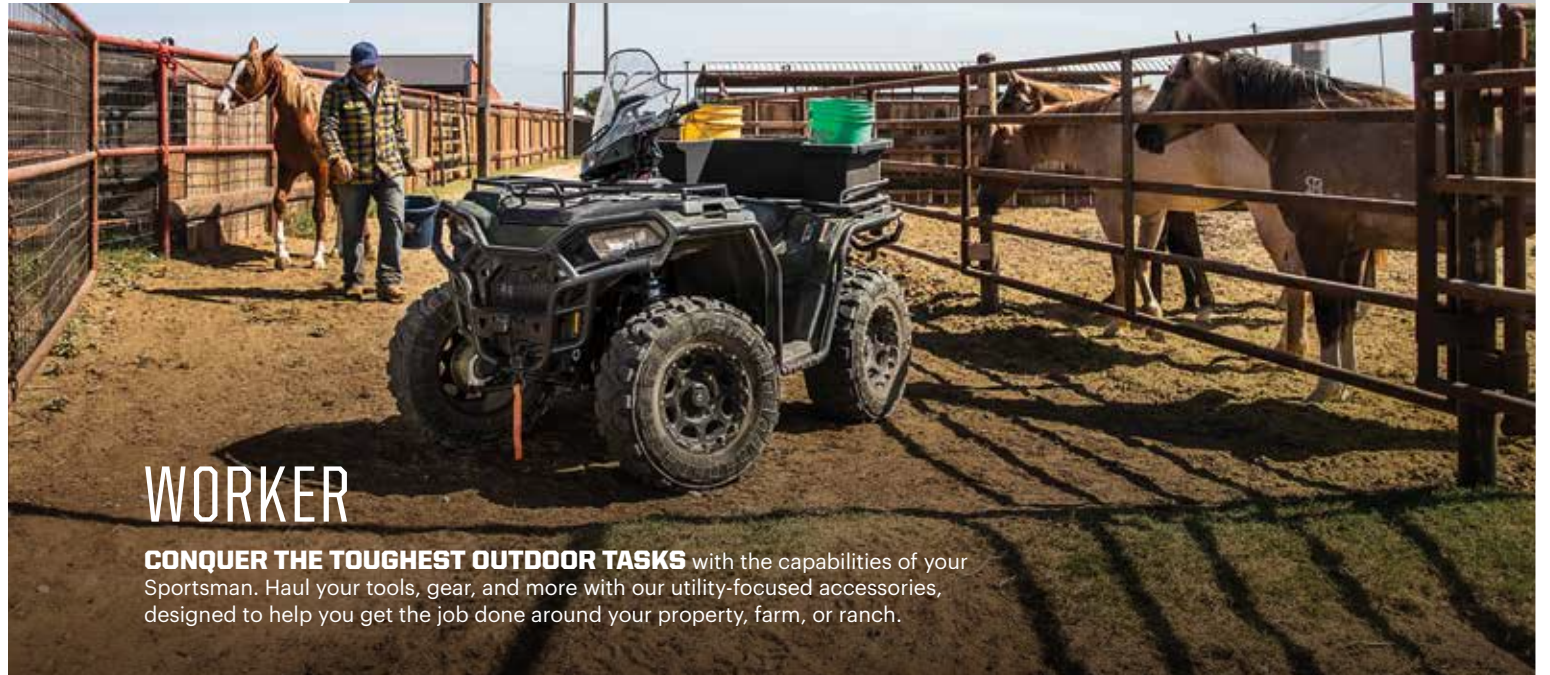

## WORKER

**CONQUER THE TOUGHEST OUTDOOR TASKS** with the capabilities of your Sportsman. Haul your tools, gear, and more with our utility-focused accessories, designed to help you get the job done around your property, farm, or ranch.

Polaris HD 1,134 kg Winch	P. 14	Rear Rack Extender	P. 15	<b>LOCK &amp; RIDE</b> Open Cargo Box	P. 17
Rear Brushguard	P. 14	Front Utility Rack	P. 15	<b>LOCK &amp; RIDE</b> Mid Windshield	P. 18
HD Front Brushguard with Hitch	P. 14	Rear Utility Rack	P. 15	Pro Armor Wheel & Tire Set: Harvester/4204	P. 43
Body Armor	P. 15	Rear Power Harness	P. 16	Lug Nuts	P. 43



## WINTER

**GET MORE DONE** with your Sportsman no matter what season it is. Conquer the toughest winter chores with our winter accessories to maximize comfort while plowing more snow in colder weather.

Polaris Pro HD 1,588 kg Winch	P. 14	<b>LOCK &amp; RIDE</b> Rear Cargo Box	P. 17	Glacier Pro Plow Blade - 167.6 cm Poly	P. 35
HD Front Brushguard with Hitch	P. 14	<b>LOCK &amp; RIDE</b> Tall Windshield	P. 18	RIGID SR-Series 25.4 cm Combo LED Light	P. 45
Rear Rack Extender	P. 15	Glacier Integrated Plow Mount	P. 35	Lightbar Harness	P. 45
Hand & Thumb Warmer Kit	P. 16	Glacier Pro Steel ATV Plow Frame	P. 35		



# SPORTSMAN 450 • 570



## WINCHES

### POLARIS PRO HD 1,588 kg WINCH TOP SELLER

- Adds 1,588 kg of pulling capacity with Auto Stop Technology for plowing applications
- Rapid Rope Recovery recovers open cable 5x as fast as standard mode on other Polaris winches

» 2884834

SPORTSMAN 450/570 '21-23



### LEARN MORE

P. 10

### POLARIS HD 1,588 kg WINCH TOP SELLER

- Adds 1,588 kg of pulling capacity with quick and easy installation
- Includes all components required for installation plus 15m of .5 cm premium high-strength synthetic rope

» 2884833

SPORTSMAN 450/570 '21-23



### POLARIS HD 1,134 kg WINCH TOP SELLER

- Adds 1,134 kg of pulling capacity with quick and easy installation
- Includes all components required for installation plus 15m of .5 cm high-strength steel cable

» 2884832

SPORTSMAN 450/570 '21-23



NEED A PLOW? SEE P. 34

## PROTECTION

### TRAIL BRUSHGUARD TOP SELLER

- Provides enhanced protection from brush and debris
- Has designated light bar holes and is compatible with winch and Body Armor

» 2884844

SPORTSMAN 450/570 '21-23



### REAR BRUSHGUARD TOP SELLER

- Protect your vehicle from brush, sticks, rocks and light bumps into solid objects
- Made of sturdy 3.2 cm steel tube with a matte black finish

» 2884847

SPORTSMAN 450/570 '21-23



### HD FRONT BRUSHGUARD WITH HITCH

- Adds heavy-duty protection with a custom look
- Has designated light bar holes and is compatible with winch and Body Armor
- Standard front receiver hitch for additional functionality

» 2884850

SPORTSMAN 450/570 '21-23



### NEW BOOT GUARDS

- Made from High Density Poly Ethylene (HDPE)
- Comes with two front guards, one for the left and right
- Protects the CV boot

» 2890059

SPORTSMAN 450/570 '21-23



### BODY ARMOR

- Provides extra protection to your ATV's full body and fenders

» 2884851

SPORTSMAN 450/570 '21-23  
FRONT BUMPER (2884850 OR 2884844) REQUIRED FOR INSTALLATION  
DOES NOT WORK WITH KOLPIN STRONGHOLD® AUTO-LATCH GUN MOUNT (2884846)



### SKID PLATE

- Built to be tough from 10mm thick High Density Poly Ethylene (HDPE)

» 2884852

SPORTSMAN 450/570 '21-23



## RACKS

### NEW CARGO RACK

- Provides extra storage and a sturdy platform for securing items to the back of your ATV
- Replaces your stock rear bumper while increasing your rack size by 33%
- Virtually limitless number of tie-down points
- Has a steel matte black finish

» 2890037

SPORTSMAN 450/570 '21-23  
WILL NOT WORK WITH REAR BUMPER;  
SERVES AS REAR BUMPER / REAR CARGO RACK



### REAR RACK EXTENDER TOP SELLER

- Forms a 7.6 cm tall perimeter around the rear cargo rack to keep gear secure which maximizes your cargo capabilities
- Durable steel construction provides a sturdy tie-down anchor for loose gear
- Compatible with Cargo Boxes and Rear Utility Rack

» 2884841

SPORTSMAN 450/570 '21-23



### FRONT UTILITY RACK TOP SELLER

- Tubular steel rack that attaches on top of front plastic rack providing protection and multiple tie-down points
- 1.9 cm diameter matte black steel tube

» 2884842

SPORTSMAN 450/570 '21-23, EXCEPT '21 AND PRIOR 6X6, X2 AND TOUR MODELS  
DOES NOT WORK WITH KOLPIN STRONGHOLD® AUTO-LATCH GUN MOUNT (2884846)



### REAR UTILITY RACK TOP SELLER

- Replaces rear plastic rack with a strong flat steel rack with integrated tie-down points
- Works with all Lock & Ride accessories, rack extenders, and gun mounts

» 2884843

SPORTSMAN 450/570 '21-23





# SPORTSMAN 450 • 570



## COMFORT



### HANDGUARDS

- BRIGHT WHITE 2876883
- BLACK TOP SELLER 2876846
- INDY RED 2876845

- Handguard Mount (2889341) is required when installing Polaris Handguards
- Does not fit with windshields or Handlebar Mounted Mirrors

» 2889341 • MOUNT  
SPORTSMAN 450/570 '21-23



### HAND & THUMB WARMER KIT TOP SELLER

- Provides heat to grips and throttle and is easily installed by plugging into pod
- Includes two heated grips and one throttle warmer

» 2885002  
SPORTSMAN 450/570 '21-23



### HANDLEBAR MOUNTED MIRRORS TOP SELLER

- Enhances visibility of what's behind you for added safety
- Sold as a pair
- Does not fit with windshields or Handguards

» 2877222  
SPORTSMAN 450/570 '21-23



### LED LIGHT KIT

- Upgrade your standard headlights and pod lights to LEDs with this upgrade kit

» 2884859  
SPORTSMAN 450/570 '21-23



### REAR POWER HARNESS

- Provides power to the rear of the ATV for electrical accessories including Rear Audio Storage Box

» 2889070  
SPORTSMAN 450/570 '21-23

## AUDIO



### LOCK & RIDE REAR AUDIO STORAGE BOX

- Dual 15.2 cm speakers by Rockford Fosgate that connect via Bluetooth
- Mounts easily with Lock & Ride to the rear rack and is compatible with rack extenders, utility rack, and gun mount
- Rest easy knowing that your speakers are protected with a sealed-lid container
- Rear Power Harness required for installation (2889070)

» 2884856  
SPORTSMAN 450/570 '21-23



### AUDIO STORAGE BOX REMOTE

- Easily control the volume or switch to the next song on your Rear Audio Storage Box
- Conveniently mounts to your ATV's handlebars

» 2884987  
SPORTSMAN 450/570 '21-23

## STORAGE

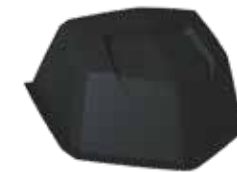

### POD BAG

- Keep your essentials in reach with 2 Liters of storage capacity
- Mounts to the top of the light pod with HD Velcro
- Semi-rigid construction and PU Laminated EVA material keeps belongings protected from the elements
- Compatible with windshields

» 2889286  
SPORTSMAN 450/570 '21-23



### FENDER BAG

- Provides easy-access 8.3 Liters of storage
- Mounts to the front left fender with HD Velcro
- Semi-rigid construction and PU Laminated EVA material keeps belongings protected from the elements

» 2889287  
SPORTSMAN 450/570 '21-23



### REAR RACK EXTENDER BAGS

- Three bags included (Rear Rack Extender sold separately)
- Mounts to Rear Rack Extender with HD Velcro
- Add a convenient 1 Liter of storage without sacrificing the rear rack
- Made to withstand the elements and wear with durable ballistic nylon construction (1680 Nylon and 600D SPD)
- Rear Rack Extender (2884841) is required

» 2889411  
SPORTSMAN 450/570 '21-23

### UNDERSEAT BAG

- Provides an extra 8.3 Liters of storage capacity
- Mounts directly under your seat via a Velcro wrap
- Durable semi-rigid construction keeps items protected

» 2889454  
SPORTSMAN 450/570 '21-23



### LOCK & RIDE REAR CARGO BOX

- Increase your storage with an extra 80.4 liters of dry, dust-proof storage
- Mounts easily with Lock & Ride to the rear rack and is compatible with rack extenders, utility rack, and gun mount
- Includes 2 padlock locations

» 2884853  
SPORTSMAN 450/570 '21-23



### LOCK & RIDE OPEN CARGO BOX

- Increase your storage with an extra 83.3 liters of convenient storage space
- Mounts easily with Lock & Ride to the rear rack and is compatible with rack extenders, utility rack, and gun mount
- Holds two 18.9-liter buckets with integrated grab handle to make it easy to carry and transport cargo
- 12 convenient tie-down locations to secure cargo

» 2884854  
SPORTSMAN 450/570 '21-23



### LOCK & RIDE REAR COOLER BOX

- Increase your storage with an extra 46 quarts of weather resistant cooler storage
- Mounts easily with Lock & Ride to the rear rack and is compatible with rack extenders, utility rack, and gun mount
- Integrated bottle opener and 2 padlock locations

» 2884857  
SPORTSMAN 450/570 '21-23





# SPORTSMAN 450 • 570



**DO MORE**

## WINDSHIELDS



Tall 48.9 cm Clear  
2884945



Mid 39.4 cm Clear  
2884845



Tall 48.9 cm Clear  
2889491

### LOCK & RIDE WINDSHIELDS

- Lock & Ride technology allows for easy installation and removal in seconds without tools
- Poly windshields are flexible, impact-resistant, and provide long-term value over the life of your machine
- Two heights available for whatever coverage you prefer
- Does not work with Handguards or Handlebar Mounted Mirrors

SIZE	COLOR	PART #
TALL 48.9 cm	CLEAR	2884945
MID 39.4 cm	CLEAR	2884845

SPORTSMAN 450/570 '21-'23

TALL 48.9 cm	CLEAR	2889491
--------------	-------	---------

SPORTSMAN 450/570 '23 WITH 7" DISPLAY INSTALLED



## PLOWS P.34



## WHEELS & TIRES P.38



## LIGHTING P.44



## HUNT P.46





# SPORTSMAN

2014-2021  
570 X2

2014-2022  
570 6X6

570 TOURING



## WINCHES

### POLARIS HD 1,588 kg WINCH TOP SELLER

» 2880434  
X2 570 '15-21, TOURING 570 '14-22, 6X6 570 '17-22



### POLARIS HD 1,134 kg WINCH TOP SELLER

» 2880432  
X2 570 '15-21, TOURING 570 '14-22, 6X6 570 '17-22



NEED A PLOW? SEE P. 34

## STORAGE



### SEMI-RIGID TOURING CARGO BAG

- Large-capacity, heavy-duty vinyl bag
- Three zippered openings, removable dividers
- Attaches to rack with Velcro straps

» 2877220  
TOURING 570 '14-22

## COMFORT



### HAND WARMERS TOP SELLER

» 2877363  
X2 570 '15-21, TOURING 570 '14-22, 6X6 570 '17-22

### HANDGUARDS

- BRIGHT WHITE 2876883
- BLACK TOP SELLER 2876846
- INDY RED 2876845

- Handguard Mount (2889341) is required when installing Polaris Handguards
- Does not fit with windshields or Handlebar Mounted Mirrors

» 2889341 • MOUNT  
X2 570 '15-21, TOURING 570 '14-22, 6X6 570 '17-22



### THROTTLE/THUMB WARMER TOP SELLER

» 2877364  
X2 570 '15-21, TOURING 570 '14-22, 6X6 570 '17-22



### HANDLEBAR MOUNTED MIRRORS TOP SELLER

- Enhances visibility of what's behind you for added safety
- Sold as a pair
- Does not fit with Windshield Fairing or Handguards

» 2877222  
X2 570 '15-21, TOURING 570 '14-22, 6X6 570 '17-22

## PROTECTION, RACKS & WINDSHIELDS



### FRONT BRUSHGUARD TOP SELLER

» 2879714  
X2 570 '15-21, TOURING 570 '14-22, 6X6 570 '17-22



### REAR BRUSHGUARD

» 2879715  
TOURING 570 '14-22



### ULTIMATE SERIES FRONT RACK EXTENDER 10.2 CM TOP SELLER

» 2879716  
X2 570 '15-21, TOURING 570 '14-22, 6X6 570 '17-22



### LOCK & RIDE YUKON ADVENTURE RACK

- Adds increased storage volume by allowing you to increase storage height securely

» 2882084  
6X6 570 '17-22

### LOCK & RIDE WINDSHIELDS

- Lock & Ride technology allows for easy installation and removal in seconds without tools
- Poly windshields are flexible, impact-resistant, and provide long-term value over the life of your machine
- Does not work with Handguards

SIZE	COLOR	PART #
TALL 48.9 cm	CLEAR	2880539-409
MID 39.4 cm	SMOKE	2880540-412

X2 570 '18-21, TOURING 570 '18-22



Tall 48.9 cm Clear



Mid 39.4 cm Smoke



COMFORT ESSENTIALS



Polaris Pro HD 1,588 kg Winch	P. 24	<b>LOCK &amp; RIDE</b> Rear Audio Storage Box	P. 27	Pro Armor Wheel & Tire Set: Dual Threat/4202	P. 43
Ultimate Series Rear Rack Extender	P. 24	Audio Storage Box Remote	P. 27	Lug Nuts	P. 43
Ultimate Series Front Brushguard	P. 25	Handguards	P. 27	RIGID D-Series Pro Driving LED Light	P. 44
Ultimate Series Rear Brushguard	P. 25	Handguard Mount	P. 27	Lightbar Harness	P. 45
Pod Bag	P. 26	Rear Power Harness	P. 27	LED Y-Harness	P. 45

HUNTER



Polaris HD 1,588 kg Winch	P. 24	<b>LOCK &amp; RIDE</b> Tall Windshield	P. 28	Lightbar Harness	P. 45
Ultimate Series Rear Rack Extender	P. 24	Pro Armor Wheel & Tire Set: Mud XC/4205	P. 43	Gun Boot L	P. 46
Ultimate Series Front Brushguard	P. 25	Lug Nuts	P. 43	Stronghold Auto-Latch Mount	P. 46
Hand & Thumb Warmer Kit	P. 27	RIGID SR-Series 25.4 cm Combo LED Light	P. 45	<b>LOCK &amp; RIDE</b> Rhino Grip Pro	P. 47

WORKER



Polaris HD 1,134 kg Winch	P. 24	Ultimate Series Rear Brushguard	P. 25	<b>LOCK &amp; RIDE</b> Mid Windshield	P. 28
Ultimate Series Rear Rack Extender	P. 24	Ultimate Series Body Armor	P. 25	Pro Armor Wheel & Tire Set: Harvester/4204	P. 43
Ultimate Series Front Steel Rack	P. 25	<b>LOCK &amp; RIDE</b> Open Cargo Box	P. 26	Lug Nuts	P. 43
Ultimate Series Front Brushguard	P. 25	Rear Power Harness	P. 27		

WINTER



Polaris Pro HD 1,588 kg Winch	P. 24	Hand & Thumb Warmer Kit	P. 27	Glacier Pro Plow Blade - 167.6 cm Poly	P. 35
Ultimate Series Rear Rack Extender	P. 24	<b>LOCK &amp; RIDE</b> Tall Windshield	P. 28	RIGID SR-Series 25.4 cm Combo LED Light	P. 45
Ultimate Series Front Brushguard	P. 25	Glacier Integrated Plow Mount	P. 35	Lightbar Harness	P. 45
<b>LOCK &amp; RIDE</b> Rear Cargo Box	P. 26	Glacier Pro Steel ATV Plow Frame	P. 35		



# SPORTSMAN 850 XP 1000 XP 1000 S



## WINCHES

### POLARIS PRO HD 1,588 kg WINCH

» 2883580

SPORTSMAN XP 1000 S '20-23

» 2889471

SPORTSMAN 850 '12-23, SPORTSMAN XP 1000 '15-23,  
SPORTSMAN TOURING XP 1000 '15-23,  
SPORTSMAN TOURING 850 '15-23



LEARN MORE  
P. 10

### POLARIS HD 1,588 kg WINCH

» 2889470

SPORTSMAN 850 '12-23, SPORTSMAN XP 1000 '15-23,  
SPORTSMAN TOURING XP 1000 '15-23,  
SPORTSMAN TOURING 850 '15-23



### POLARIS HD 1,134 kg WINCH

» 2889469

SPORTSMAN 850 '12-23, SPORTSMAN XP 1000 '15-23,  
SPORTSMAN TOURING XP 1000 '15-23,  
SPORTSMAN TOURING 850 '15-23



NEED A PLOW? SEE P. 34

## RACKS

### ULTIMATE SERIES RACK EXTENDER 10.2 cm

#### FRONT

» 2882022

SPORTSMAN XP 1000 S '20-23,  
SPORTSMAN 850/1000 '17-23



#### REAR

» 2882023

SPORTSMAN XP 1000 S '20-23,  
SPORTSMAN 850/1000 '17-23  
FITS WITH REAR CARGO BOX (2882882)



### ULTIMATE SERIES RACK EXTENDER 17.8 cm

#### FRONT

» 2882024

SPORTSMAN XP 1000 S '20-23,  
SPORTSMAN 850/1000 '17-23  
NOT SHOWN

#### REAR

» 2882025

SPORTSMAN XP 1000 S '20-23,  
SPORTSMAN 850/1000 '17-23  
DOES NOT FIT WITH REAR CARGO BOX (2882882)



### FRONT RACK EXTENDER

» 2879890

SPORTSMAN 850/1000 TOURING '10-23  
DOES NOT FIT WITH FRONT CARGO BOX (2877951)

### ULTIMATE SERIES STEEL RACK

#### FRONT

» 2883257

SPORTSMAN XP 1000 S '20-23,  
SPORTSMAN 850/1000 '17-23



#### REAR

» 2883258

SPORTSMAN XP 1000 S '20-23,  
SPORTSMAN 850/1000 '17-23



### ULTIMATE SERIES MOVEABLE TIE-DOWN POINTS

» 2882270

(FRONT & REAR - SOLD IN PAIRS)  
SPORTSMAN 850/1000 '17-23



## PROTECTION



### ULTIMATE SERIES BRUSHGUARD

- Quick installation to the integrated mounting tubes on the vehicle using wedge-style expansion anchor mounts
- Attach the Body Armor to the Front Brushguard to provide the ultimate protection for the front fenders

» 2882020 • FRONT **TOP SELLER**

SPORTSMAN XP 1000 S '20-23,  
SPORTSMAN 850/1000 '17-23

» 2882583 • REAR **TOP SELLER**

SPORTSMAN XP 1000 S '20-23,  
SPORTSMAN 850/1000 '17-23



### ULTIMATE SERIES BODY ARMOR

- Securely mounts to Ultimate Series Sportsman XP Front Brushguard (2882020)
- Comes as pair

» 2882090

SPORTSMAN 850/1000 '17-23  
DOES NOT WORK WITH GUN BOOT MOUNT (2882036)



### TOURING XP BRUSHGUARD

- Adds heavy-duty protection and a custom look

» 2878709 • FRONT

SPORTSMAN 850/1000 TOURING '10-23

» 2878324 • REAR

SPORTSMAN 850/1000 TOURING '10-23



# SPORTSMAN 850 XP 1000 XP 1000 S



## STORAGE



### LOCK & RIDE REAR CARGO BOX

- Increase your storage with an extra 80.4 liters of dry, dust-proof storage
- Mounts easily with Lock & Ride to the rear rack and is compatible with rack extenders and gun mount
- Includes 2 padlock locations
- Will not fit when Ultimate Series Steel Rack is installed

» 2884853

SPORTSMAN XP 1000 S '20-23, SPORTSMAN 850/1000 '17-23



### LOCK & RIDE OPEN CARGO BOX

- Increase your storage with an extra 83.3 liters of convenient storage space
- Mounts easily with Lock & Ride to the rear rack and is compatible with rack extenders and gun mount
- Holds 2, 18.9-liter buckets with integrated grab handle to make it easy to carry and transport cargo
- 12 convenient tie-down locations to secure cargo
- Includes 2 padlock locations
- Will not fit when Ultimate Series Steel Rack is installed

» 2884854

SPORTSMAN XP 1000 S '20-23, SPORTSMAN 850/1000 '17-23



### LOCK & RIDE REAR COOLER BOX

- Increase your storage with an extra 46 quarts of weather-resistant cooler storage space
- Mounts easily with Lock & Ride to the rear rack and is compatible with rack extenders and gun mount
- Integrated bottle opener and 2 padlock locations
- Will not fit with Ultimate Series Steel Rack

» 2884857

SPORTSMAN XP 1000 S '20-23, SPORTSMAN 850/1000 '17-23

### POD BAG

- Keep your essentials in reach with 2 Liters of storage capacity
- Mounts to the top of the light pod with HD Velcro
- Semi-rigid construction and PU Laminated EVA material keeps belongings protected from the elements
- Compatible with windshields

» 2889286

SPORTSMAN 850/1000 21-23



### ULTIMATE SERIES READY PACK

- Keep your trail essentials at the ready with this easy-to-access, weather-resistant storage compartment

» 2882271

SPORTSMAN 850/1000 '17-23



### LOCK & RIDE FRONT CARGO BOX

» 2877951

SPORTSMAN 850/1000 TOURING '10-23  
FRONT RACK EXTENDER CANNOT BE INSTALLED AT THE SAME TIME AS FRONT CARGO BOX



### LOCK & RIDE REAR STORAGE BOX

» 2878000

SPORTSMAN 850/1000 TOURING '10-23  
SLIGHT INTERFERENCE WITH SPORTSMAN TOURING 550/850 '11-14 PASSENGER HANDLES  
DOES NOT FIT '21 TOURING MODELS

## AUDIO



### LOCK & RIDE REAR AUDIO STORAGE BOX

- Dual 15.2 cm speakers by Rockford Fosgate that connect via Bluetooth
- Mounts easily with Lock & Ride to the rear rack and is compatible with rack extenders and gun mount
- Rest easy knowing that your speakers are protected with a sealed-lid container
- Rear Power Harness (2889071) is required, sold separately

» 2884856

SPORTSMAN XP 1000 S '20-23, SPORTSMAN 850/1000 '17-23



### AUDIO STORAGE BOX REMOTE

- Easily control the volume or switch to the next song on your Rear Audio Storage Box
- Conveniently mounts to your ATV's handlebars

» 2884987

SPORTSMAN XP 1000 S '20-23, SPORTSMAN 850/1000 '17-23

## COMFORT



### HANDLEBAR MOUNTED MIRRORS TOP SELLER

- Enhances visibility of what's behind you for added safety
- Sold as a pair
- Does not fit with Windshield Fairing or Handguards

» 2877222

SPORTSMAN XP 1000 S '20-23, SPORTSMAN 850/1000 TOURING '10-23,  
SPORTSMAN 850/1000 '09-23



### HANDGUARDS

<input type="checkbox"/> BRIGHT WHITE	2876883
<input checked="" type="checkbox"/> BLACK <small>TOP SELLER</small>	2876846
<input type="checkbox"/> INDY RED	2876845

- Handguard Mount (2889341) is required when installing Polaris Handguards
- Does not fit with windshield or Handlebar Mounted Mirrors

» 2889341 • MOUNT

SPORTSMAN XP 1000 S '20-23, SPORTSMAN 850/1000 TOURING '10-23,  
SPORTSMAN 850/1000 '09-23



### HAND & THUMB WARMER KIT TOP SELLER

- Provides heat to grips and throttle and is easily installed by plugging into pod
- Includes two heated grips and one throttle warmer

» 2885002

SPORTSMAN 850/1000 '21-23



### HAND WARMERS TOP SELLER

» 2877363

SPORTSMAN XP 1000 S '20, SPORTSMAN XP 1000 '15-20,  
SPORTSMAN 850 '15-20, SPORTSMAN TOURING XP 1000 '15-23,  
SPORTSMAN TOURING 850 '15-23



### THROTTLE/THUMB WARMERS TOP SELLER

» 2877364

SPORTSMAN XP 1000 S '20, SPORTSMAN XP 1000 '15-20,  
SPORTSMAN 850 '15-20, SPORTSMAN TOURING XP 1000 '15-23,  
SPORTSMAN TOURING 850 '15-23



### REAR POWER HARNESS

- Provides power to the rear of the ATV for electrical accessories including Rear Audio Storage Box

» 2889071

SPORTSMAN XP 1000 S '20-23, SPORTSMAN XP 1000 '17-23, SPORTSMAN 850 '17-23



# SPORTSMAN 850 XP 1000 XP 1000 S



## DO MORE

### WINDSHIELDS

#### LOCK & RIDE WINDSHIELDS

- Provides enhanced protection from the elements and off-road hazards
- Easily installs and removes without tools utilizing Lock & Ride technology
- Improved mounting system for easier and quicker attachment and detachment

SIZE	COLOR	PART #
TALL 48.9 cm	CLEAR	2884945
MID 39.4 cm	CLEAR	2884845

SPORTSMAN XP 1000 S '21-23, SPORTSMAN XP 1000 '21-23, SPORTSMAN 850 '21-23



Tall 48.9 cm Clear  
2884945



Mid 39.4 cm Clear  
2884845



Tall 48.9 cm Clear  
2889491

SIZE	COLOR	PART #
TALL 48.9 cm	CLEAR	2889491

SPORTSMAN XP 1000 S '22-23, SPORTSMAN XP 1000 '22-23, SPORTSMAN 850 '22-23 WITH 7" DISPLAY POWERED BY RIDE COMMAND INSTALLED

#### LOCK & RIDE WINDSHIELDS

- Installs and removes in seconds without tools with Lock & Ride technology
- Poly windshields are flexible, impact-resistant, and provide long-term value over the life of your machine
- Does not work with Handguards

SIZE	COLOR	PART #
TALL 48.9 cm	CLEAR	2880539-409
MID 39.4 cm	SMOKE	2880540-412

SPORTSMAN TOURING XP 1000 '15-23, SPORTSMAN TOURING 850 '15-23



Tall 48.9 cm Clear  
2880539-409



Mid 39.4 cm Smoke  
2880540-412

#### LOCK & RIDE ULTIMATE SERIES WINDSHIELD FAIRING

- Customizable system based on your style and protection needs
- Install the fairing to add one of the Ultimate Series Windshields below
- Does not work with Handguards or Handlebar Mounted Mirrors

» 2882512

SPORTSMAN XP 1000 S '20, SPORTSMAN XP 1000 '17-20, SPORTSMAN 850 '17-20



#### ULTIMATE SERIES WINDSHIELDS

- Fairing required to add your preferred windshield

SIZE	PART #
TALL 50.8 cm	2882152
MID 40.6 cm	2882151

SPORTSMAN XP 1000 S '20, SPORTSMAN XP 1000 '17-20, SPORTSMAN 850 '17-20



EASY TO CHANGE WINDSHIELDS WITH G-DART INSTALL

Our fairing system allows for changing out the windshield quickly and easily. Simply remove the six dart-type fasteners and swap out the windshield.

**PLOWS**  
P. 34



**WHEELS & TIRES**  
P. 38



**LIGHTING**  
P. 44



**HUNT**  
P. 46





# SCRAMBLER 850 XP 1000 S



# MISCELLANEOUS ACCESSORIES

## COMFORT



### HANDGUARD

- Handguard Mount (2889341) is required when installing Polaris Handguards
- Does not fit with windshield or Handlebar Mounted Mirrors

SPORTSMAN XP 1000 S '20-23, SPORTSMAN 850/1000 TOURING '10-23, SPORTSMAN 850/1000 '09-23

<input type="checkbox"/> BRIGHT WHITE	2876883
<input checked="" type="checkbox"/> BLACK <small>TOP SELLER</small>	2876846
<input type="checkbox"/> INDY RED	2876845

» 2889341 • MOUNT



## RACKS/STORAGE



### LARGE REAR RACK

» 2879139  
SCRAMBLER XP 1000 S '20-23, SCRAMBLER XP 1000 '14-18, SCRAMBLER 850 '14-23  
NOT COMPATIBLE WITH OGIO BAG (2879925)



### OGIO BAG

» 2879925  
SCRAMBLER XP 1000 S '20-23, SCRAMBLER XP 1000 '14-18, SCRAMBLER 850 '14-23

## PROTECTION



### ULTIMATE SPORT SERIES FRONT BRUSHGUARD

» 2883595  
SCRAMBLER XP 1000 S '20-23



### FRONT BRUSHGUARD

» 2879136  
SCRAMBLER 850 '14-23, SCRAMBLER XP 1000 '14-18  
REPLACES EXISTING LOWER BUMPER – WILL NOT WORK TOGETHER

## WINCHES

### POLARIS PRO HD 1,588 kg WINCH



» 2883580  
SCRAMBLER XP 1000 S '20-23

» 2889471  
SCRAMBLER 850 '14-23,  
SCRAMBLER XP 1000 '14-18

### POLARIS HD 1,588 kg WINCH

» 2889470  
SCRAMBLER 850 '14-23,  
SCRAMBLER XP 1000 '14-18



### POLARIS HD 1,134 kg WINCH

» 2889469  
SCRAMBLER 850 '14-23,  
SCRAMBLER XP 1000 '14-18



### RIDE & REPAIR ESSENTIALS KIT

- 12-volt DC portable air compressor
  - Tire repair kit with 6 plugs
  - Basic first-aid kit with bandages, scissors, safety pins, and more
  - 12-volt jumper cables
  - Duct tape – 300mm x 1 roll
  - Zip ties – 150mm length
  - Electrical tape
  - Ratchet strap – 50mm
  - Microfiber cloth
  - Carry bag
- » 2881207



### QUICKTAP BATTERY POSTS

- Easy-to-access terminal posts give you quick access to the battery power
  - Ideal for charging your battery, powering a temporary accessory, or when you need to offer an unexpected jump-start
  - Connection posts feature covers to protect terminals when not in use
- » 2882110



### ATV LICENSE PLATE

- Includes numbers and letters
- » 2873270

## TRAILERING AND RECOVERY STRAPS

SEE P. 63



# YOUTH ATV OUTLAW 70 EFI

THE PERFECT FIRST ALL-TERRAIN VEHICLE FOR  
KIDS STARTING AT 6 YEARS AND OLDER



## FRONT BRUSHGUARD

- Provides enhanced protection from brush and other debris on the trail

» 2884567  
OUTLAW 70 EFI '21-23



## REAR BRUSHGUARD

- Protect the rear of your youth ATV from hazards on the trails

» 2884778  
OUTLAW 70 EFI '21-23



## WINDSHIELD - POLY

- Added wind and hand protection with a durable poly design

» 2885005  
OUTLAW 70 EFI '21-23

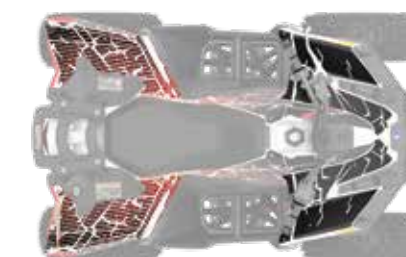

## DECAL KIT - INDY RED

- Replaces the stock Outlaw 70 decals to provide a unique and custom look for your youth ATV

» 2885107  
OUTLAW 70 EFI '21-23



## REAR STORAGE BAG

- Convenient storage that easily connects to the rear rack

» 2884555  
OUTLAW 70 EFI '21-23





# PLow SYSTEM



TAKE COMMAND OF CLEARING SNOW AND MAKE QUICK WORK OF EVEN THE HEAVIEST JOBS.

## THE POLARIS ENGINEERED ADVANTAGE

### INSTALLATION

30 seconds: Drive up, clip in, lock down, and go — the integrated Polaris Engineered Glacier Plow System simplifies plowing.



### CONVENIENCE

Lift and angle adjustments can be made from the driver's seat.

ANGLE YOUR BLADE RIGHT FROM YOUR SEAT with the Glacier Pro plow hydraulic angle system



### ROBUST FRAME

A plow system is only as strong as its frame, and Polaris Engineered plow frames have a wide frame to withstand the rigors of heavy plowing.



### DURABLE BLADES

Available in strong stamped steel or corrosion-resistant poly materials, Polaris Engineered plow blades cover a large surface area for quick snow removal.

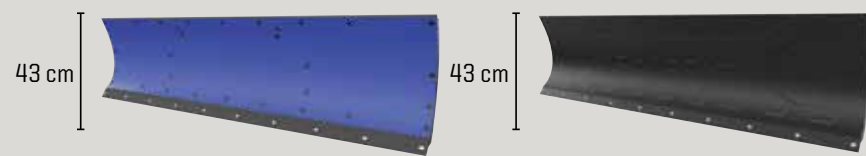

168 cm POLY BLADE

152 cm & 132 cm STEEL BLADE

## PLow SYSTEMS (WINCH REQUIRED, SOLD SEPARATELY)

Choose a Glacier Plow System, designed to help you get the most out of your Sportsman during snowy months. Select a system based on your plowing needs with premium add-ons including a hydraulic lift system or additional plow accessories.

### GLACIER PRO HD PLOW SYSTEM WITH HYDRAULICS

- System includes:
- Mount (2881424)
  - Frame (2879630)
  - 167.64 cm Poly Plow (2880269)
  - Hydraulic Angle (2879635)
  - Hydraulic Controller (2880836)
  - Plow Markers (2872726)
  - Plow Deflector (2879866)

» **3880010**  
450 '15-23, 570 '15-23, 6X6 570 '17-22, X2 570 '15-21, 570 TOURING '15-22  
REQUIRES LIFT METHOD: SEE WINCHES BELOW

### GLACIER PRO HD PLOW SYSTEM

- System includes:
- Mount (2881424)
  - Frame (2879630)
  - 152.4 cm Steel Plow (2879638)

» **3880011**  
450 '15-23, 570 '15-23, 6X6 570 '17-22, X2 570 '15-21, 570 TOURING '15-22  
REQUIRES LIFT METHOD: SEE WINCHES BELOW

### GLACIER PRO HD PLOW SYSTEM WITH HYDRAULICS

- System includes:
- Mount (2881423)
  - Frame (2879630)
  - 167.64 cm Poly Plow (2880269)
  - Hydraulic Angle (2879635)
  - Hydraulic Controller (2880836)
  - Plow Markers (2872726)
  - Plow Deflector (2879866)

» **3880012**  
XP 1000 '15-23, 850 '15-23, TOURING 1000 '15-23, TOURING 850 '15-23, SCRAMBLER 850 '15-23  
REQUIRES LIFT METHOD: SEE WINCHES BELOW

### GLACIER PRO HD PLOW SYSTEM

- System includes:
- Mount (2881423)
  - Frame (2879630)
  - 152.4 cm Steel Plow (2879638)

» **3880013**  
XP 1000 '15-23, 850 '15-23, TOURING 1000 '15-23, TOURING 850 '15-23, SCRAMBLER 850 '15-23  
REQUIRES LIFT METHOD: SEE WINCHES BELOW



ADD HYDRAULICS



**25°**  
LEFT AND RIGHT

CONTROL FROM THE PALM OF YOUR HAND

Change the angle of the plow blade with the Power Controller.

HYDRAULIC CONTROL FOR EXTREME SNOW REMOVAL

NEED TRACKS?  
SEE P. 36

GLACIER PRO HD GIVES YOU:

168 cm, 152 cm or 132 cm Blades

Choice of poly or steel

Ability to add a hydraulic angle system

MODELS	MANDATORY STEPS			OPTIONAL
	STEP 1 SELECT A MOUNT	STEP 2 SELECT A FRAME	STEP 3 SELECT PLOW CONFIGURATION	STEP 4 ADD HYDRAULICS
XP 1000 '15-23 850 '15-23 850/XP 1000 HIGHLIFTER '16-23 TOURING XP 1000 '15-23 TOURING 850 '10-23 SCRAMBLER 850 '14-23	TOP SELLER 2881423		Polaris Pro HD 1,588 kg Winch 2889471 Polaris HD 1,588 kg Winch 2889470 Polaris HD 1,134 kg Winch 2889469	
XP 1000 S '20-23 SCRAMBLER XP 1000 S '20-23	2883581		Polaris Pro HD 1,588 kg Winch 2883580	168 cm Poly 2880269
570 '15-20 6X6 570 '17-22 X2 570 '15-21 TOURING 570 '14-22 450 H.O. '12-20		TOP SELLER 2879630	Polaris HD 1,588 kg Winch TOP SELLER 2880434 Polaris HD 1,134 kg Winch TOP SELLER 2880432	TOP SELLER 152 cm Steel 2879638 TOP SELLER 132 cm Steel 2879639
570 '21-23 450 H.O. '21-22	TOP SELLER 2881424		Polaris Pro HD 1,588 kg Winch TOP SELLER 2884834 Polaris HD 1,588 kg Winch TOP SELLER 2884833 Polaris HD 1,588 kg Winch TOP SELLER 2884832	Hydraulic Plow Blade Angle System 2879635 Power Controller 2880836 <small>POWER CONTROLLER RECOMMENDED</small>

### STEP 5 SELECT ACCESSORIES AND REPLACEMENT ITEMS

168 cm HD Wear Bar 2879868 168 cm Wear Bar 2879867 152 cm Wear Bar 2877243 132 cm Wear Bar 2877210	168 cm Plow Blade Snow Deflector 2879866 Plow Blade Deflector 2871808 Skid Shoe 2208864 Glacier Pro Shear Pin Replacement 2205063 Coil Spring Spacer 2872655	Plow Winch Rope For 1,134 kg & 1,588 kg winches   2878483 Glacier Plow Marker Sold in pairs   2872726 Rear Tire Chains Recommended for rear tires only   2881422 Plow Blade Track Extension Required for track equipped vehicles   2879719
---	--	---

CHOOSE A PLOW SYSTEM

BUILD A PLOW SYSTEM

COMMON  
WINCHES  
450 - 570  
850 - XP 1000 S  
SCRAMBLER 850 - XP 1000 S  
MISC & YOUTH  
PLOWING TRACKS  
WHEELS & TIRES  
LIGHTING  
HUNT & COOLERS



# ALL-TERRAIN TRACTION

It's tough to make Sportsman even more versatile than it already is. But with a set of Prospector Pro Tracks, you'll do just that. Tread through deep snow without concern.

Polaris-specific gearing provides 1:1 ratio to:

- Minimize track slip, providing better climbing ability and improved traction in deep snow
- Improve top speed over prior models by approximately 5%
- Reduce operating RPM for a quieter ride
- Improve driveline durability, which allows vehicle to run at a lower RPM, decreasing engine wear

Polaris exclusive optimized hub geometry that minimizes feedback and eases steering effort

Lightweight design provides for better flotation, eases steering effort, and provides better vehicle control

Flexible lug design provides the highest level of deep snow performance by lifting up in deep snow as opposed to digging down

New front dual stabilizer for improved stability

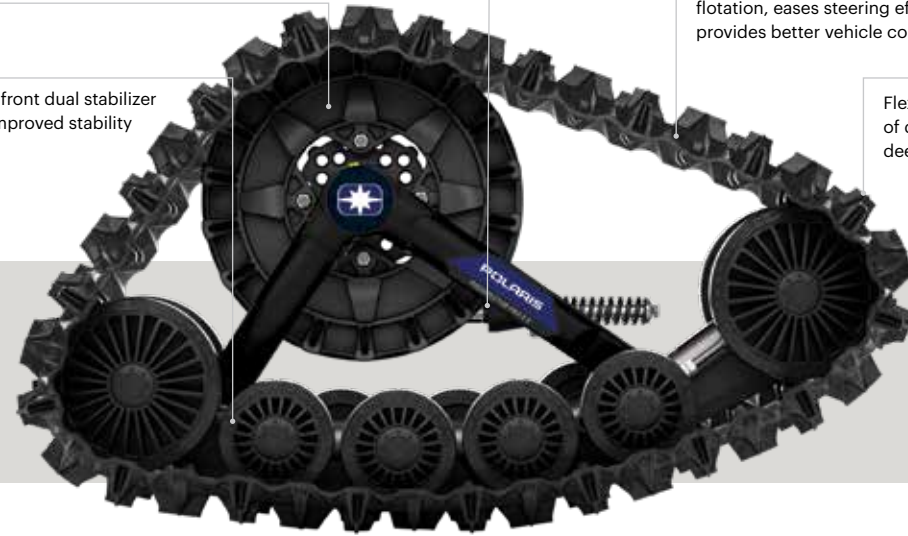

## PROSPECTOR PRO 2.0 TRACK SYSTEM

STEP 1: SELECT A MOUNT KIT		
MODELS	A-ARMS	MOUNT KIT
SPORTSMAN XP 1000/850 '15-23 SPORTSMAN TOURING XP 1000/850 '15-23	STRAIGHT	2879457
SPORTSMAN XP 1000/850 '16-23 HIGHLIFTER 1000/850 '16-23	ARCHED	2882109
SPORTSMAN XP 1000 S '20-23 SCRAMBLER XP 1000 S '20-23	ARCHED	2883977
SPORTSMAN 570 '21-23	ARCHED	2889218
SPORTSMAN 570 '21-23	STRAIGHT	2889219
SPORTSMAN 570 '15-23 SPORTSMAN TOURING 570 '15-22 SPORTSMAN X2 570 '15-21	STRAIGHT	2879497

STEP 2: SELECT A TRACK KIT		
MODELS	EPS	TRACK KIT
SPORTSMAN 570 '15-23 SPORTSMAN TOURING 570 '15-22 SPORTSMAN X2 570 '15-21	YES	2889493
SPORTSMAN XP 1000/850 '15-23 SPORTSMAN TOURING XP 1000/850 '17-23 HIGHLIFTER 1000 '16-23 SPORTSMAN XP 1000 S '20-23 SCRAMBLER XP 1000 S '20-23	YES	2889495
SPORTSMAN 570 '14-23 SPORTSMAN TOURING 570 '15-22	NO	2889492
SPORTSMAN XP 1000 '18-23 SPORTSMAN 850 '15-23 SCRAMBLER 850 '13-23	NO	2889494

TRACK AND MOUNT KIT		
MODELS	EPS	TRACK AND MOUNT KIT
SPORTSMAN 570 6X6 '17-22	YES	2882169

## WANT TO PLOW?

### GLACIER PRO PLOW TRACK EXTENSION









- Plow extension for use when using the Prospector Pro Track System and Glacier Pro Sportsman plow system

» 2879719

FOR USE WITH GLACIER PRO PLOW SYSTEMS

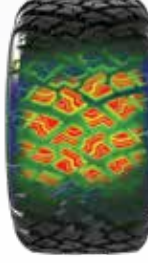

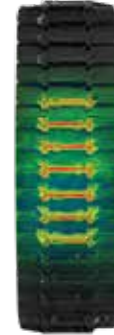
# SPORTSMAN SNOW TRACTION OPTIONS

TREAD THROUGH SNOW WITH THESE OPTIONS	CONTACT PATCH	TURNING RADIUS
 <p><b>STOCK TIRES</b></p>	<p><b>GOOD</b></p> 	<p><b>354.3 cm</b></p> 
 <p><b>PRO ARMOR WHITEOUT</b></p>	<p><b>BETTER</b></p>  <p>More surface area for better flotation on snow</p>	<p><b>352.743 cm</b></p> 
 <p><b>PROSPECTOR PRO 2.0 TRACKS</b></p>	<p><b>BEST</b></p>  <p>Less aggressive tread displaces snow for better handling</p>	<p><b>445.453 cm</b></p> 

COMMON

WINCHES

450-570

850-XP1000-XP1000S

SCRAMBLER 850-XP1000S

MISC & YOUTH

PLOW & TRACKS

WHEELS & TIRES

LIGHTING

HUNT & COOLERS



# KNOW YOUR TERRAIN



- Tread patterns optimized for extreme traction
- Ideal for both hard pack and loose trail



- Flexible "grippy" tread
- Aggressive side bite



- Provides traction and durability
- Built to perform in hard sand, jagged rocks or any other extreme terrain



- Extra deep treads
- Self-cleaning lugs



- Paddles provide traction and durability in soft sand
- Built to float on top of sand



- Triple-belted sidewalls to resist puncture
- Purpose-built, long lasting tread patterns



- Handles extreme cold
- Holds shape and provides traction

# SUPERIOR PERFORMANCE & DURABILITY

# WAYS TO SHOP WHEELS & TIRES



## LIFELONG PERFORMANCE

- Every tire is designed and constructed with longevity in mind
- 3,000+ mile rated (4,828 kilometers)

## PREMIUM PROTECTION

- Pro Armor makes tires with extra protection exactly where it's needed most — the sidewall
- Triple-belted sidewalls keep your tires more resistant so you can keep going

## TOUGH TIRES

- Higher ply ratings mean added protection
- Pro Armor builds 8 or 10-ply rated tires for higher puncture-resistance



## KNOW YOUR TIRES

DIMENSIONS			TREAD DEPTH	TIRE WEIGHT	PLY RATING	SIDEWALL BELTS	LOAD RATING
TIRE HEIGHT	TIRE WIDTH	WHEEL DIAMETER					
<b>32" x 9"</b>	<b>R15</b>	<b>FRONT/REAR</b>	<b>30 mm</b>	<b>18 kg</b>	<b>10</b>	<b>3</b>	<b>499 kg</b>
Part Number							

**USAGE**  
Where can you use the tire

**TREAD DEPTH**  
Deeper treads have more grip in all conditions

**TIRE WEIGHT**  
A lighter tire makes for improved vehicle performance

**PLY RATING**  
Indicates tire puncture-resistance

**SIDEWALL BELTS**  
Increase your resistance to sidewall punctures

**LOAD RATING**  
How much weight can the tire handle

## TIRES BY SIZE

26"	27"
ATTACK	HARVESTER
DUAL-THREAT	MUD XC
HARVESTER	PRESERVE
PRESERVE	WHITEOUT
XD-K	X TERRAIN

## TIRES BY TERRAIN

TRAIL	ROCK	DESERT	MUD	UTILITY	SNOW
ATTACK	ATTACK	ATTACK	MUD XC	ATTACK	ATTACK
DUAL-THREAT	DUAL-THREAT	DUAL-THREAT		HARVESTER	HARVESTER
HARVESTER				PRESERVE	PRESERVE
MUD XC				XD-K	XD-K
PRESERVE				X TERRAIN	WHITEOUT
X TERRAIN					
XD-K					

## TIRES



### PRO ARMOR DUAL-THREAT

- Dual-compound technology and radial construction offer performance in all terrains
- Softer durometer rubber on outer edge for overall superior grip and feel
- Harder durometer rubber in the middle for increase traction during acceleration and longer tread life

		TREAD DEPTH	TIRE WEIGHT	PLY RATING	SIDEWALL BELTS	LOAD RATING
14"	<b>26" x 9" R14</b> 5416340	FRONT	<b>12 kg</b>	<b>10</b>	<b>3</b>	<b>413 kg</b>
14"	<b>26" x 11" R14</b> 5416341	REAR	<b>14 kg</b>			<b>504 kg</b>



FRONT/REAR

WHEEL SIZE  
**14"**



### PRO ARMOR ATTACK

- The best all-purpose tire for all-season traction in any terrain
- Unique full-face tread design
- Harder durometer lugs promote extended wear, increasing tire life

		TREAD DEPTH	TIRE WEIGHT	PLY RATING	SIDEWALL BELTS	LOAD RATING
14"	<b>26" x 9" R14</b> 5415613	FRONT	<b>13 kg</b>	<b>8</b>	<b>3</b>	<b>413 kg</b>
14"	<b>26" x 11" R14</b> 5415614	REAR	<b>15 kg</b>			<b>599 kg</b>



FRONT/REAR

WHEEL SIZE  
**14"**

COMMON

WINCHES

450-570

850-XP1000-XP1000S

SCRAMBLER 850-XP1000S

MISC & YOUTH

PLOWS & TRACKS

WHEELS & TIRES

LIGHTING

HUNT & COOLERS



# TIRES



## PRO ARMOR HARVESTER

- All-around workhorse with tread life of 8,047 kilometers
- Tread pattern designed to withstand anything from the farmyard to the pastures to the trail
- With 10-ply, it can carry the load day-in and day-out

		TREAD DEPTH	TIRE WEIGHT	PLY RATING	SIDEWALL BELTS	LOAD RATING
12"	26" x 8" R12 5416396	FRONT	11 kg			388 kg
12"	26" x 10" R12 5415966	REAR	15 kg	10	3	615 kg
14"	27" x 10" R14 5415965	FRONT/REAR	15 kg			599 kg



## PRO ARMOR WHITEOUT

- Extra wide tires for flotation in snow
- Tread pattern designed for superior snow traction with limited digging

		TREAD DEPTH	TIRE WEIGHT	PLY RATING	SIDEWALL BELTS	LOAD RATING	
14"	27" x 14" R14 5416032	FRONT/REAR	16 mm	11 kg	8	3	424 kg



## PRO ARMOR PRESERVE

- Turf-friendly for areas where low impact from tire tread is needed
- Exceptionally quiet-running and low impact

		TREAD DEPTH	TIRE WEIGHT	PLY RATING	SIDEWALL BELTS	LOAD RATING
12"	26" x 8" R12 5416403	FRONT	11 kg			388 kg
12"	26" x 10" R12 5416402	REAR	13 kg	10	3	599 kg
14"	27" x 10" R14 5416348	FRONT/REAR	13 kg			599 kg



## NEW X TERRAIN

- Built to perform through the toughest obstacles on any trail
- Durability-driven design to provide a comfortable, confident ride
- 8-ply, triple-belted ballistic sidewalls resist punctures

		TREAD DEPTH	TIRE WEIGHT	PLY RATING	SIDEWALL BELTS	LOAD RATING	
14"	27" x 9" R14 5418330	FRONT	16 mm	12 kg	8	3	365 kg
14"	27" x 11" R14 5418331	REAR		14 kg			438 kg



## PRO ARMOR XD-K

- 26" Aramid fiber-belted tire can tackle any terrain
- Unique full-face tread design
- Harder durometer lugs promote extended wear, increasing tire life

		TREAD DEPTH	TIRE WEIGHT	PLY RATING	SIDEWALL BELTS	LOAD RATING	
12"	26" x 9" R12 5415756	FRONT	31.7 mm	13 kg	8	3/1 Aramid	388 kg
12"	26" x 11" R12 5415757	REAR		15 kg			499 kg



## PRO ARMOR MUD XC

- Designed as the perfect mud-trail crossover for a smooth ride on the trail and aggressive traction in the mud
- Dual-compound technology with harder durometer lugs promotes extended wear, increasing tire life
- 10-ply construction means added protection in the toughest terrain

		TREAD DEPTH	TIRE WEIGHT	PLY RATING	SIDEWALL BELTS	LOAD RATING	
14"	27" x 9" R14 5416947	FRONT	30 mm	14 kg	10	3	531 kg
14"	27" x 11" R14 5416948	REAR		15 kg			599 kg





# WHEELS



BEADLOCK REQUIRED

BEADLOCK INCLUDED

INNER AND OUTER BEADLOCK INCLUDED

40-SERIES

14"

## A 4101

WEIGHT: 6.6 kg LOAD RATING: 363 kg OFFSET: -35

MATTE BLACK: FRONT/REAR 14" x 10" 1522958

## D 4203 BEADLOCK

FRONT WEIGHT: 5.9 kg LOAD RATING: 408 kg OFFSET: +4  
REAR WEIGHT: 6.6 kg LOAD RATING: 590 kg OFFSET: -9

MATTE BLACK: FRONT 14" x 7" 1522238-458  
REAR 14" x 8" 1522239-458

## G 4206

FRONT WEIGHT: 4.3 kg LOAD RATING: 408 kg OFFSET: +4  
REAR WEIGHT: 4.9 kg LOAD RATING: 590 kg OFFSET: -9

MATTE BLACK: FRONT 14" x 6" 1522542-458  
REAR 14" x 8" 1522543-458

## E 4201

FRONT WEIGHT: 5.9 kg LOAD RATING: 408 kg OFFSET: +9  
REAR WEIGHT: 6.4 kg LOAD RATING: 590 kg OFFSET: +9

ACCENT: FRONT 14" x 7" 1522956-266  
REAR 14" x 8" 1522957-266  
MATTE BLACK: FRONT 14" x 7" 1522956-458  
REAR 14" x 8" 1522957-458

## E 4204

FRONT WEIGHT: 5.9 kg LOAD RATING: 408 kg OFFSET: +4  
REAR WEIGHT: 6.4 kg LOAD RATING: 590 kg OFFSET: -9

ACCENT: FRONT 14" x 7" 1522546-266  
REAR 14" x 8" 1522547-266  
MATTE BLACK: FRONT 14" x 7" 1522546-458  
REAR 14" x 8" 1522547-458

## H 4301 BEADLOCK

WEIGHT: 7.3 kg LOAD RATING: 726 kg OFFSET: +38

ACCENT: FRONT/REAR 14" x 7" 1523284  
MATTE BLACK: FRONT/REAR 14" x 7" 1523283

## C 4202

FRONT WEIGHT: 5.8 kg LOAD RATING: 408 kg OFFSET: +4  
REAR WEIGHT: 6.1 kg LOAD RATING: 590 kg OFFSET: -9

ACCENT: FRONT 14" x 7" 1522544-266  
REAR 14" x 8" 1522545-266  
MATTE BLACK: FRONT 14" x 7" 1522544-458  
REAR 14" x 8" 1522545-458

## F 4205

FRONT WEIGHT: 4.8 kg LOAD RATING: 408 kg OFFSET: +4  
REAR WEIGHT: 5.7 kg LOAD RATING: 590 kg OFFSET: -9

MATTE BLACK: FRONT 14" x 7" 1521507-521  
REAR 14" x 8" 1521508-521  
LUSTER: FRONT 14" x 7" 1521507-410  
REAR 14" x 8" 1521508-410

## I HD DUAL BEADLOCK

WEIGHT: 18.1 kg LOAD RATING: 725.7 kg OFFSET: +38

MATTE BLACK: FRONT/REAR 14" x 7" 1524022-458

## KNOW YOUR WHEELS

### STEP 1: SELECT SERIES

4 = 40-SERIES

### STEP 2: CHOOSE LOAD RATING

- 1 = <362.9 kg
- 2 = 363 - 589.7 kg
- 3 = 590 - 726+ kg

### STEP 3: PICK STYLE

OFFSET / BEADLOCK / COLOR

INCREASE OFFSET FROM STOCK = NARROWER STANCE  
DECREASE OFFSET FROM STOCK = WIDER STANCE

## 2 WAYS TO PURCHASE

INDIVIDUAL WHEELS & TIRES  
- OR -  
COMPLETE SETS AS LISTED

Exclusively at Polaris Authorized Dealers

## 14" FORGED BEADLOCK RINGS

Sold Individually



- A** Machined  
Only used on 4203 Beadlock & HD Dual Beadlock 1522244-266
- B** Beadlock Ring - Matte Black - 14"  
Only used on 4301 Beadlock & HD Dual Beadlock 1523146-458

## KNOW YOUR TERRAIN



• Tread patterns optimized for extreme traction  
• Ideal for both hard pack and loose trail



• Extra deep treads  
• Self-cleaning lugs



• Triple-belted sidewalls to resist puncture  
• Purpose-built, long lasting tread patterns



• Handles extreme cold  
• Holds shape and provides traction

# WHEEL & TIRE SETS

	TRAIL X TERRAIN 27"	ATTACK 26"	DUAL-THREAT 26"	MUD MUD XC 27"	UTILITY PRESERVE 27"	HARVESTER 27"	SNOW WHITEOUT 27"
4101 Matte Black							2882382
4201 Accent	2889966	2882390	2883138	2884272	2883208	2882388	
4201 Matte Black	2889967	2882391	2883139	2884273	2883209	2882389	
4202 Accent	2889968	2881335	2883140	2884267		2882383	
4202 Matte Black	2889969	2881336	2883141	2884268	2883204	2882384	
4203 BEADLOCK Matte Black BEADLOCKS SOLD SEPARATELY	2889972	2881381					
4204 Accent	2889973	2881347	2883142	2884270	2883205	2882385	
4204 Matte Black	2889974	2881348	2883143	2884271		2882386	
4205 Luster		2881359	2883144				
4205 Matte Black	2889975	2881360	2883145	2884269	2883207	2882387	
4206 Matte Black		2881404					
4301 BEADLOCK Accent BEADLOCKS PRE-MOUNTED	2889970		2883217				
4301 BEADLOCK Matte Black BEADLOCKS PRE-MOUNTED	2889971		2883216				

## LUG NUTS

LUG NUTS REQUIRED



### METRIC LUG NUTS FOR ALUMINUM RIMS

- » 2877385 • SET OF 4
- » 2877384 • SET OF 16 SPORTSMAN XP

### SAE LUG NUTS FOR ALUMINUM RIMS

- » 2876754 • SET OF 4
- » 2877409 • SET OF 16 SPORTSMAN 450/570

## REPLACEMENT CAPS

### CENTER CAP

LUSTER	ALL WHEELS EXCEPT 4204 & 4203 BEADLOCK	1521509-410
MATTE BLACK		1521509-521
HD MATTE BLACK	ALL WHEELS	5457498-458

### PRO ARMOR CENTER CAP

LUSTER	ALL WHEELS EXCEPT 4204 & 4203 BEADLOCK	5453209-410
MATTE BLACK		5453209-458

## TIRE SEALANT

P. 62

- » 946 mL • 2830484
- » 3.8 LITER • 2830485
- » 19 LITER • 2830486
- » 19 LITER, PUMP • 2830487

## COLBY VALVE SHORT ULTIMATE VALVE - 2 PACK

- » 2883292

## COLBY VALVE EMERGENCY VALVE - 2 PACK

- » 2883293

## COLBY COMBO VALVE KIT - 16 PACK

- Includes eight Ultimate Valves and eight Emergency Valves
- » 2883294





**POLARIS ENGINEERED ADVANTAGES**

**MOUNTS PERFECTLY**  
Designed for your Polaris Engineered bumper, roof or other mounting point

**MAX PERFORMANCE**  
Validated to work as hard as your machine does

**DOESN'T OVERTAX**  
Trust it to work when you need it to



**ADVANCED TECH**

RIGID lights are driven by Aluminum PCB Smart Boards, 6063-T5 aircraft aluminum extruded housings and Tiger Drylac UV protection polyester powdercoating.

**EXCLUSIVE OPTICS**

RIGID lights feature impact-resistant polycarbonate lenses for a 100% water/dustproof seal.

**RUGGED CONSTRUCTION**

Pro Armor lights are designed to be big and beefy with an aggressive style all their own, and housed in IP67 marine-grade rated UV polyester powdercoating.

**MASSIVELY BRIGHT**

Pro Armor builds bright lights designed for any riding experience. All that power is directed through heat dissipating aluminum for streamlined heat management.

**LIGHT BAR TYPES**



**SR-SERIES PRO**

Sleek, powerful, low-profile (under 5 cm tall). Lights extreme distances with low energy usage.

Available in 25.4 cm



**D-SERIES PRO**

Compact to fit almost anywhere with high output and low energy usage.

Available in Driving, Flood & Spot



**SINGLE-ROW LED**

Powerful, compact, low-profile light bars with sleek look.

Available in 50.8 cm



**CUBE LED**

Small size allows mounting in strategic locations for added lighting.

Available in Spot

**LIGHT BAR OPTIONS**

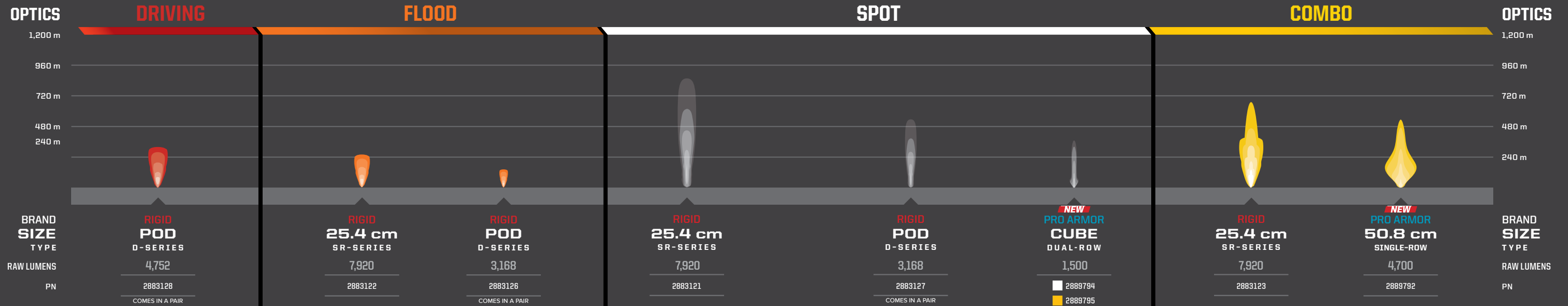

**BUILD YOUR VISION**

Consider the optics, angle and how you will use your vehicle to choose the right light or set of lights.

OPTICS LIGHT ANGLE	ACCENT	DRIVING (45°)	FLOOD (25°)	SPOT (10°)	COMBO (25°/10°)
DRIVING SPEED	All	Slow	Medium	Fast	Medium to fast
BEAM	Diffused glow	Extra-wide	Wide/Shorter	Concentrated/Long	Inner spot & outer flood
RECOMMENDED MOUNTING	Low/Wheel well	All points	Low &/or rear	High points	All points
TERRAIN & RIDING STYLE	Added style & personalization in any terrain	All riding & utility	Wide-open terrain or trails & utility	Trail & tight conditions	All riding & utility

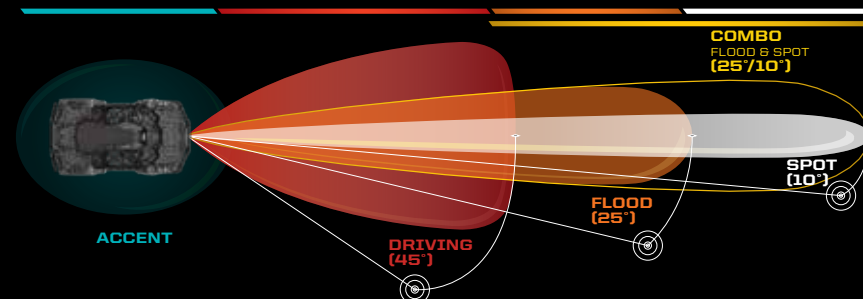

**POLARIS ENGINEERED**

**LED LIGHTING**

**LED LIGHT KIT**

Upgrade your standard headlights and pod lights to LEDs with this upgrade kit

» 2884859

SPORTSMAN XP 1000 S '21-'23,  
SPORTSMAN 850/1000 '21-'23,  
SPORTSMAN 450/570 '21-'23  
DOES NOT WORK WITH MODELS PRIOR TO '21



**WIRING HARNESSES**

**LIGHTBAR HARNESS**

Control one light with one switch

» 2882320  
ALL SPORTSMAN MODELS

**LED Y-HARNESS**

Requires 2882320 to control two cubes or two lights with one switch

» 2879860  
ALL SPORTSMAN MODELS

COMMON

WINCHES

450-570

850-XP1000-XP1000S

SCRAMBLER 850-XP1000S

MISC & YOUTH

PLOWS & TRACKS

WHEELS & TIRES

LIGHTING

HUNT & COOLERS



# PROTECTING YOUR ESSENTIAL GEAR SINCE 1943



Never transport a loaded firearm. Verify firearm is unloaded prior to mounting. Please refer to local laws and regulations regarding the requirements for the legal transport of firearms.

## KOLPIN STRONGHOLD SYSTEM

Polaris is proud to partner with Kolpin Outdoors, an industry leader in off-road accessories and the premier name in gun boots and mounts. If you need to secure a firearm while riding, simply attach the auto-latch mount and choose your Gun Boot.

### IDEAL FOR SECURE TRANSPORT OF SCOPED RIFLES AND SHOTGUNS



#### STEP 1 CHOOSE YOUR MOUNT



##### STRONGHOLD AUTO-LATCH MOUNT

- The auto-latching design provides quick and secure Kolpin Stronghold product attachment
- Bracket is made from rugged high impact, reinforced nylon and coated steel with precision angle adjustment for a custom fit
- For use with the Kolpin Stronghold line of products (sold separately)

» 2882272  
SPORTSMAN 850/1000 '17-23  
DOES NOT FIT WITH ULTIMATE SERIES – BODY ARMOR (2882090)

##### STRONGHOLD AUTO-LATCH MOUNT

- The auto-latching design provides quick and secure Kolpin Stronghold product attachment
- Bracket is made from rugged high impact, reinforced nylon and coated steel with precision angle adjustment for a custom fit
- For use with the Kolpin Stronghold line of products (sold separately)

» 2884846  
SPORTSMAN 450/570 '21-23

#### STEP 2 CHOOSE YOUR BOOT

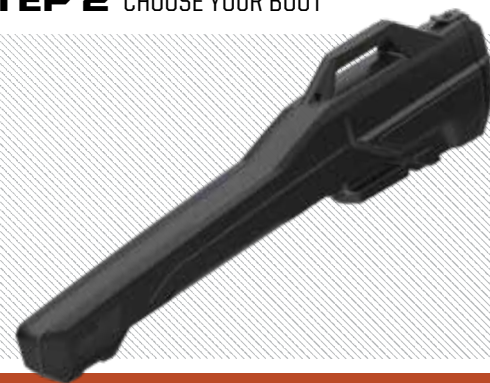

##### GUN BOOT L

- 132.1 cm L x 12.1 cm W x 23.5 cm H
- Requires Auto-Latch Mount 2882272 or 2884846 to mount to vehicle

» 2882426  
SPORTSMAN 850/1000 '17-23,  
SPORTSMAN 450/570 '14-23

##### GUN BOOT XL

- Lockable and TSA Approved
- Includes padded, zippered internal protective liner
- 132.1 cm L x 9.5 cm W x 26.6 cm H
- Requires Auto-Latch Mount 2882272 or 2884846 to mount to vehicle

» 2882036  
XP 1000 '17-23, 850 '17-23, 570 '19-23, 450 H.O. '21-23



## KOLPIN RHINO GRIP IDEAL FOR CARRYING RIFLES, SHOTGUNS, BOWS AND CROSSBOWS.



##### LOCK & RIDE RHINO GRIP PRO

- » 2884119
- » 2884109 - REPLACEMENT RUBBER STRAPS  
ALL SPORTSMAN MODELS (EXCEPT UTILITY EDITIONS & YOUTH)



##### LOCK & RIDE RATCHETING RHINO GRIP

- » 2881157  
ALL SPORTSMAN MODELS (EXCEPT UTILITY AND YOUTH)



##### LOCK & RIDE RHINO GRIP XLR

- » 2889147
- » 2889204 - RHINO GRIP XLR  
REPLACEMENT RUBBER STRAPS (2)
- ALL SPORTSMAN MODELS  
(EXCEPT UTILITY EDITIONS & YOUTH)



##### LOCK & RIDE RHINO GRIP XLR – DOUBLES

- » 2889148
- » 2889204 - RHINO GRIP XLR  
REPLACEMENT RUBBER STRAPS (2)
- ALL SPORTSMAN MODELS  
(EXCEPT UTILITY EDITIONS & YOUTH)



##### KOLPIN GUN BOOT IV

- For 50mm scopes, rifles with slings attached, or shotguns up to 129.54 cm in length
- » BLACK • 2872677



##### LOCK & RIDE GUN BOOT MOUNTS

- Works with Lock & Ride XL Storage Box, Lock & Ride Rear Cargo Box, and Rear Rack Extenders
- » 2878001  
SPORTSMAN 850/1000 TOURING '10-23  
ONLY COMPATIBLE WITH KOLPIN GUN BOOT IV – NOT COMPATIBLE WITH KOLPIN STRONGHOLD GUN BOOTS



# KEEP IT ICE COLD



## GRIZZLY TESTED. POLARIS APPROVED.



This cooler is IGBC-approved, meaning it withstands the power expended by a typical grizzly bear if it was trying to get inside.

Seriously, there are experts who know what a grizzly is capable of doing, and they certify our coolers can take it.



**28, 57 & 99**  
LITER FEATURES



ComfortCarry  
Handles



TravelLock  
System



EasyOut  
Drain System



NoSlip  
Rubber Feet



PolarWall  
Insulation



IceLock  
Seal

**POLARIS NORTHSTAR COOLERS CAN SURVIVE JUST ABOUT ANYTHING - FROM EXTREME HEAT TO A NASTY TUMBLE OFF A VEHICLE.**



**99 LITER**

- » GRAPHITE • 2883426
- » DESERT • 2883392



**57 LITER**

- » GRAPHITE • 2883425
- » DESERT • 2881259



**28 LITER**

- » GRAPHITE • 2883424
- » DESERT • 2881315



**14 LITER**









- » GRAPHITE • 2883968

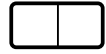

**19 LITER SOFT-SIDED COOLER**

- » GRAPHITE • 2889285

### ESSENTIAL ACCESSORIES SO YOUR COOLER WORKS AS HARD AS YOU DO

COOLER ACCESSORIES	99 LITER	57 LITER	28 LITER	DON'T FORGET THESE ACCESSORIES	
 <b>WIRE BASKET</b>	2883648	2882185	2882438	 <b>TUMBLER</b> » 591 mL • 2883393	 <b>BOTTLE OPENER</b> » 2882183 ALL COOLERS
 <b>DIVIDERS</b> Doubles as cutting board	2883468 COMES WITH ONE DIVIDER  1 way to partition	2882184 COMES WITH TWO DIVIDERS  2 ways to partition	2882186 COMES WITH ONE DIVIDER  1 way to partition		
 <b>SEAT CUSHION</b>	NOT AVAILABLE	2882179	2882507		
 <b>WHEELS</b>	2883967	2882180	NOT AVAILABLE		



# FOR THE LIFE OF YOUR RIDE

**PARTS THAT PUSH THE LIMITS WITHOUT SACRIFICING STRENGTH AND DURABILITY.**

We build our products so anyone with the right tools can maintain their vehicle.

**POLARIS**

**ENGINEERED PARTS & LUBRICANTS**

PARTS & GARAGE

MAINTENANCE

OIL & LUBRICANTS

MAINTENANCE FLUIDS

GARAGE ACCESSORIES & BATTERY CHARGERS

HD PARTS

SERVICE PARTS

TIRE SEALANT & TRAILERING

POLARIS POWER

POLARIS POWER

51

## MAINTENANCE TIP

### BREAK-IN PERIOD

The break-in period for your new Sportsman is the first 25 hours of operation, or the time it takes to use the first two tanks of fuel. No single action on your part is as important as a proper break-in period. Careful treatment of a new engine will result in more efficient performance and longer life for the engine.

**NOTICE:** Excessive heat build-up during the first three hours of operation will damage close-fitted engine parts. Do not operate at full throttle or high speeds for extended periods during the first three hours of use.

### BATTERY

To ensure a battery maintains its level of charge when unused for extended periods of time or during freezing weather, the battery should be connected to a battery charger (see P. 57). Be sure to check for corrosion from the terminals to the ends of the cables.

### BRAKE PADS

Maintaining and/or replacing brakes are critical to the safety and functionality of a vehicle. Brake pads should be checked for wear and oil or grease (petroleum products) contamination and brake discs should be checked for cracks, excessive corrosion or warping.

### HALF SHAFT

Check for tears and punctures in the boot, which can lead to CV joint wear that can contribute to axle failure.

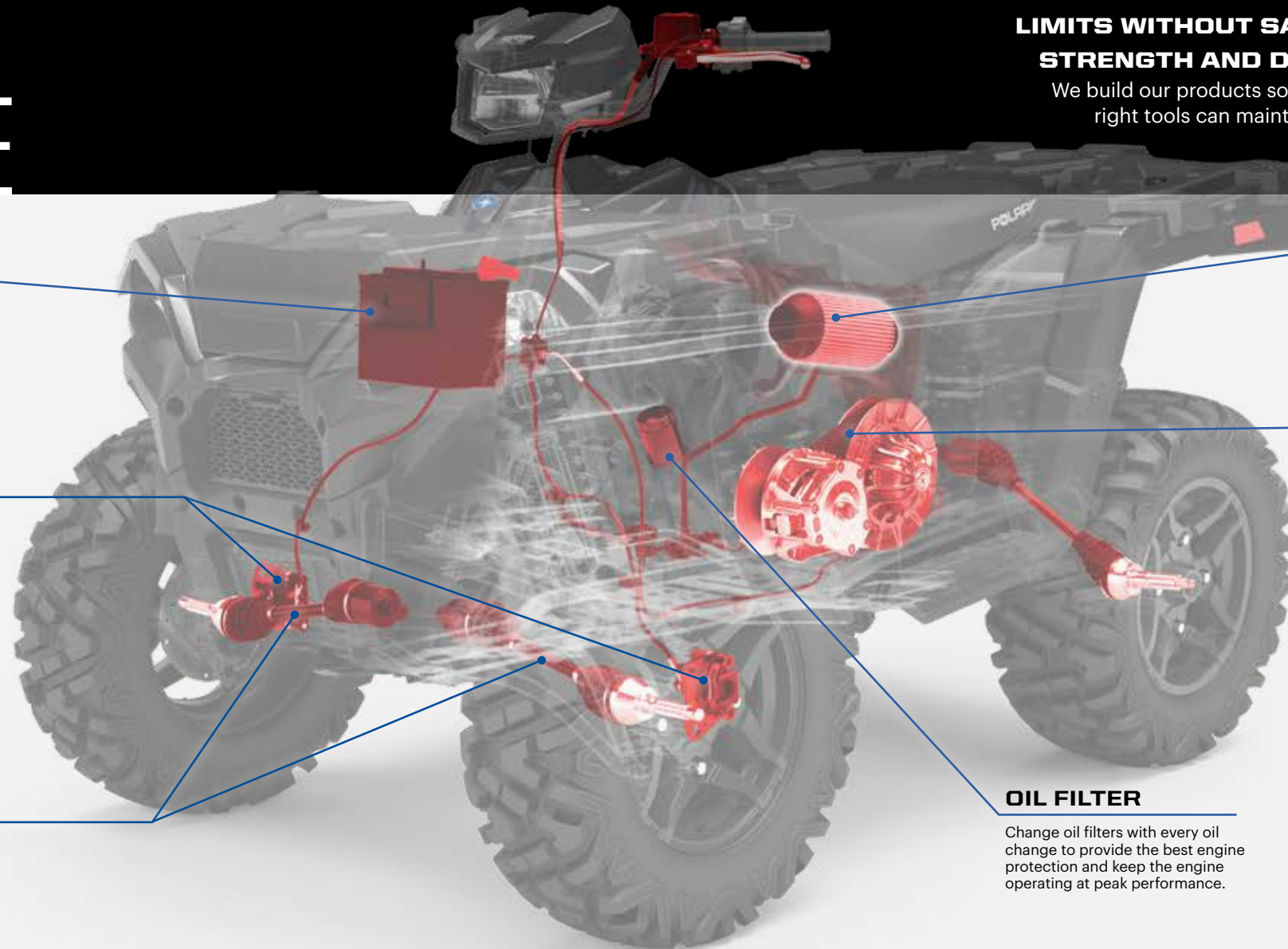

### AIR FILTER

A clogged air filter can restrict air flow to the engine leading to reduced engine performance, engine life or catastrophic failure.

### DRIVE BELT

Polaris Engineered belts deliver unmatched performance for your off-road vehicle. Developed and tested on all our engines for all environments and conditions. Check your belt for delamination, hour glassing and glazing.

#### BREAK-IN PERIOD

- Use lower gear (if available) while varying speeds and avoid wide open throttle for 8-16 km
- If no low gear is available, vary at moderate speeds while avoiding wide open throttle for 80 km

#### OUR INVESTMENT

- 64,000+ km of field testing
- Thousands of dyno hours
- 18+ months of development (13,000+ design hours) per belt
- 1,500+ vehicle validation hours
- Collaboration with powertrain and clutch engineers

#### YOUR ADVANTAGE

- No clutch recalibration
- Less wear and tear due to heat
- Ensure maximum vehicle performance
- More time riding, less time wrenching
- Produced in collaboration with powertrain and clutch engineers to ensure a perfect fit, maximum performance and ultimate durability

### OIL FILTER

Change oil filters with every oil change to provide the best engine protection and keep the engine operating at peak performance.

**FOLLOW RECOMMENDED SERVICE INTERVALS IN THE OWNER'S MANUAL**

## MAINTENANCE SCHEDULE

25 HRS / 400 km

### BREAK-IN MAINTENANCE

- ENGINE OIL:** CHANGE
- GEARCASES:** CHECK OIL LEVEL
- AIR FILTER:** INSPECT & REPLACE AS NEEDED
- EXHAUST SYSTEM:** INSPECT & CLEAN  
INSPECT FOR LEAKAGE OR CARBON BUILD UP AT JOINTS  
INSPECT & CLEAN SCREEN TYPE SPARK ARRESTOR

50 HRS / 800 km

### 6 MONTHS

- EXHAUST SYSTEM:** INSPECT & CLEAN  
INSPECT FOR LEAKAGE OR CARBON BUILD UP AT JOINTS  
INSPECT & CLEAN SCREEN TYPE SPARK ARRESTOR
- GENERAL LUBRICATION:** ALL FITTINGS, PIVOTS, CABLES, ETC.
- DRIVE BELT:** INSPECT & ADJUST  
REPLACE AS NEEDED

100 HRS / 1,600 km

### 12 MONTHS

- ENGINE OIL:** CHANGE
- DRIVE BELT:** INSPECT & ADJUST  
REPLACE AS NEEDED
- SPARK PLUGS:** REPLACE
- EXHAUST SYSTEM:** INSPECT & CLEAN  
INSPECT FOR LEAKAGE OR CARBON BUILD UP AT JOINTS  
INSPECT & CLEAN SCREEN TYPE SPARK ARRESTOR

150 HRS / 2,400 km

### 18 MONTHS

- BATTERY:** TEST, CLEAN & CHECK FLUID LEVEL  
IF NECESSARY, REPLACE AS NEEDED
- DRIVE BELT:** INSPECT & ADJUST  
REPLACE AS NEEDED
- TIRES:** INSPECT CONDITION & PRESSURE
- EXHAUST SYSTEM:** INSPECT & CLEAN  
INSPECT FOR LEAKAGE OR CARBON BUILD UP AT JOINTS  
INSPECT & CLEAN SCREEN TYPE SPARK ARRESTOR

200 HRS / 3,200 km

### 24 MONTHS

- ENGINE OIL:** CHANGE
- TRANSMISSION FLUID:** CHANGE
- GEARCASES:** CHECK OIL LEVEL
- BRAKE PADS & FLUID:** INSPECT & CLEAN  
REPLACE AS NEEDED
- SPARK PLUGS:** REPLACE
- EXHAUST SYSTEM:** INSPECT & CLEAN  
INSPECT FOR LEAKAGE OR CARBON BUILD UP AT JOINTS  
INSPECT & CLEAN SCREEN TYPE SPARK ARRESTOR

250 HRS / 4,023 km

### 30 MONTHS

- ENGINE OIL:** CHANGE
- BATTERY:** TEST, CLEAN & CHECK FLUID LEVEL  
REPLACE AS NEEDED
- DRIVE BELT:** INSPECT & ADJUST  
REPLACE AS NEEDED
- GENERAL LUBRICATION:** ALL FITTINGS, PIVOTS, CABLES, ETC.
- EXHAUST SYSTEM:** INSPECT & CLEAN  
INSPECT FOR LEAKAGE OR CARBON BUILD UP AT JOINTS  
INSPECT & CLEAN SCREEN TYPE SPARK ARRESTOR

300 HRS / 4,828 km

### 36 MONTHS

- ENGINE OIL:** CHANGE
- AIR FILTER:** INSPECT & REPLACE AS NEEDED
- GEARCASES:** CHECK OIL LEVEL
- SPARK PLUGS:** REPLACE
- EXHAUST SYSTEM:** INSPECT & CLEAN  
INSPECT FOR LEAKAGE OR CARBON BUILD UP AT JOINTS  
INSPECT & CLEAN SCREEN TYPE SPARK ARRESTOR

**CHECK YOUR OWNER'S MANUAL FOR ADDITIONAL RECOMMENDED SERVICE ITEMS AND VEHICLE-SPECIFIC TIMING**



# OIL

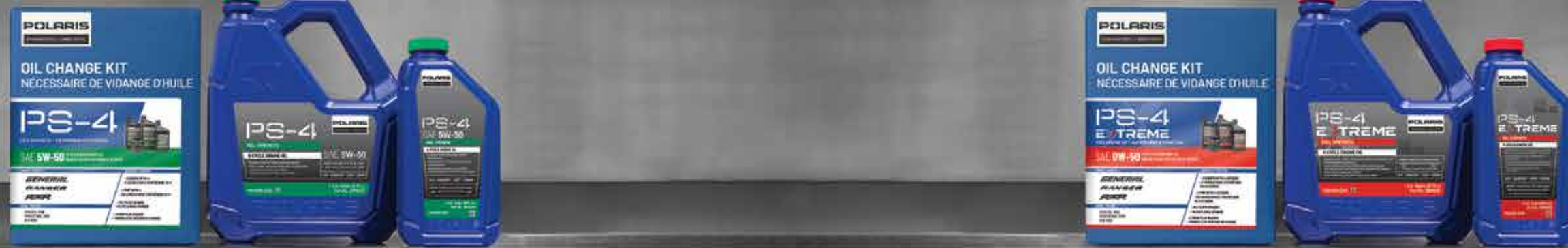

## PS-4 FORMULATIONS BEST PROTECTION, BEST PERFORMANCE

Our new PS-4 5W-50 formulation and PS-4 Extreme Synthetic 0W-50 have been designed to provide the best fluid technologies for long lasting wear protection. These formulations include a new Polaris exclusive additive system to keep the engine cleaner from deposit build-up to maximize power and powersports-grade synthetic base stocks that provide the ultimate in engine protection.

### PS-4 5W-50 FULL-SYNTHETIC OIL

Optimal for ambient operating temperatures of -40° C to 38° C

» .95L 2876244    » 3.8L 2876245    » 60.6L 2876247    » 208L Drum 2876246    » 1249L Tote 2878814

### PS-4 0W-50 EXTREME FULL-SYNTHETIC OIL

Optimal for ambient operating temperatures of -43° C to 54° C

» .95L 2889395    » 3.8L 2889396    » 60.6L 2889397    » 208L Drum 2889398    » 1249L Tote 2889399

PS-4 5W-50 OIL CHANGE KITS		NEW PS-4 EXTREME 0W-50	
These convenient kits include everything needed including filter and oil volume per vehicle			
PART NUMBER	VEHICLE FITMENT	PART NUMBER	
2202166	RANGER/RZR/SPORTSMAN 570, TWIN 600, TWIN 700, TWIN 800	2890056	
2879323	RANGER, POLARIS GENERAL 900-1000, RZR 900-1000, RS1	2890057	
2877473	RANGER/SPORTSMAN 300-500, SPORTSMAN/SCRAMBLER 500/850/1000	2890055	
2881696	RZR TURBO	2890058	

### ENGINE WEAR TEST LOWER NUMBER = LESS WEAR OF CRITICAL ENGINE PARTS LESS WEAR MEANS LONGER ENGINE LIFE

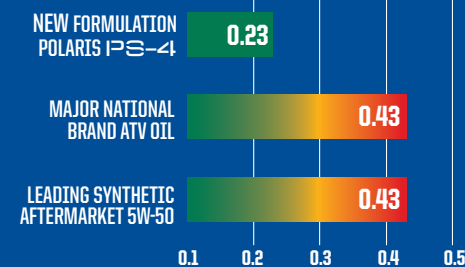

ASTM D4172. In 3rd party against 11 competitive products Polaris had 40% or better wear protection compared to all of the test products.

#### THE BEST PROTECTION

- At least 40% improved wear protection compared to previous Polaris PS-4 formulation and all aftermarket oils tested

Best engine protection against wear for the longest engine life.

### DEPOSIT TEST LOWER DEPOSITS = MAXIMUM POWER

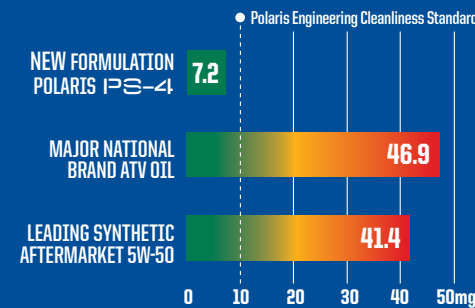

ASTM D6395. In 3rd party against 9 competitive products Polaris PS-4 had less than half the deposits compared to the next closest product. No other tested products met Polaris Engineering standards for deposit cleanliness.

#### MAXIMUM PERFORMANCE

- New improved PS-4 formulation provides 33% less deposits than previous PS-4 formula
- At least 50% less deposits than all aftermarket oils tested

The cleanest engine for maximum power and performance!

## POLARIS EXTREME SYNTHETICS

Our new PS-4 Extreme Synthetic 0W-50 formulation applies only to the **absolute highest performance** products we sell, for ultimate protection and performance in the most extreme conditions.



- Our best extreme high temp formulation, excellent for severe high temperatures and for racing, even at temps over 54°C.
- Provides easier starting and cold temperature protection, even to extreme cold temps of below -42°C.
- Latest in premium synthetic PAO and Ester base stocks along with careful balance of moly and ZDDP additives for ultimate long lasting wear protection.

- Polaris exclusive clean engine additive system reduces deposits and carbon build-up for peak performance and power.



POLARIS INVESTS IN EACH OIL AT AND ABOVE THESE LEVELS

12+ DEDICATED  
TEAM MEMBERS

FOCUSED ON  
POLARIS OIL

18+  
MONTHS

DEVELOPMENT  
& TESTING

76,000+  
HOURS

DYNO  
TESTING

3.5 MILLION+  
KILOMETERS

FIELD  
TESTING



# MAINTENANCE FLUIDS



## DOT 4 BRAKE FLUID

A high-quality brake fluid designed for use in Polaris hydraulic brakes.

Change every 200 hours, 24 months, or 3,200 km.

» 355 mL • 2872189



## AGL

Protect gears, drive chain and bearings from scoring and wear.

Change every 200 hours, 24 months or 3,218 km.

» .95 L • 2878068  
 » 3.8 L • 2878069  
 » 9.5 L • 2878070  
 » 208 L • 2879594

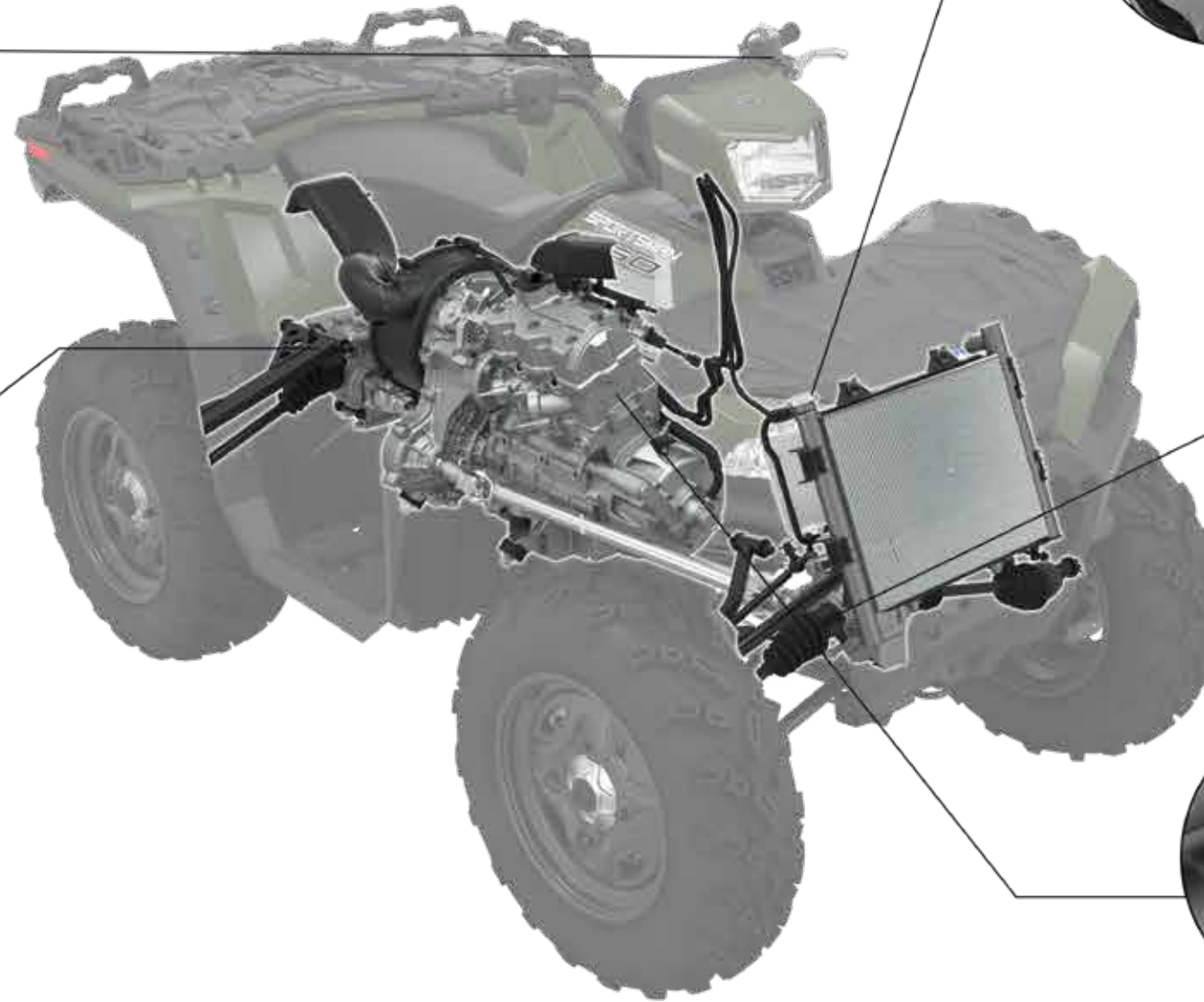

## ANTI-FREEZE

Prevent corrosion on metal components, eliminate scaling and maximize cooling system performance.

Change every 60 months.

» .95 L • 2880514  
 » 3.8 L • 2880513  
 » 208 L • 2880512



## DEMAND DRIVE FLUID

Provide positive 4WD engagement in extreme cold or high heat conditions and protect internal components under heavy loads.

Change every 100 hours or every 36 months.

» .95 L • 2877922  
 » 9.5 L • 2877923

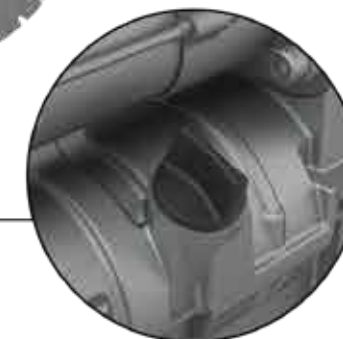

## ENGINE OIL

Maximum protection for your 4-cycle engine.

Change every 100 hours, 1,600 km or 12 months.



## ORV MAINTENANCE KIT

Everything you need, in the correct fluid volumes, to maintain your drive train and keep your vehicle in top operating condition

Includes: 1 Spark Plug, 1 Air Filter, 1.9 L PS-4, 1 Oil Filter, .47 L Demand Drive Fluid, .95 L AGL, 1 Crush Washer, 1 Paper Funnel

» 2830549

570 '14-23, 450 '16-23



## PREMIUM GAS SHOCK OIL

» .95 L • 2874124  
 WALKER EVANS RACING REBUILDABLE SHOCKS  
 » .95 L PREMIUM • 2870995  
 » 9.5 L PREMIUM • 2872279  
 FOX REBUILDABLE SHOCKS



## SUSPENSION/ U-JOINT GREASE

» 89 mL • 2871515  
 » 414 mL • 2871551



## CHAIN LUBRICANT

• Provides superior anti-wear and shock protection  
 » 473 mL AEROSOL  
 2872348



## ALL-SEASON GREASE TUBE

• Specialized water-resistant lubricant  
 » 89 mL • 2871322  
 » 414 mL • 2871423



## ANGLE DRIVE FLUID

• Extreme pressure, anti-wear and high viscosity film lubrication for maximum protection  
 » .95 L • 2889280



## GENERATOR OIL

• 4-cycle engine oil  
 » .95 L • 2879383



## CARBON CLEAN

• Ultimate fuel and injection system cleaner  
 » 355 mL • 2881413



## ADVANCED FUEL TREATMENT

• Dual antioxidant formula protects jets and fuel system from gum and varnish  
 » 355 mL • 2881416



# GARAGE ACCESSORIES



**PREMIUM MAINTENANCE TOOL KIT**

- Includes everything you need to work on and repair Polaris vehicles
- » 2830565



**FLUID FUNNEL**

- Easily add oil with high accuracy
- » 2830552



**FUNNELS**

- Unique capped design eliminates spills and contaminants
- » BLUE • 2830574
- » RED • 2830575
- » GREEN • 2830576



**HANDHELD PUMP SPRAYER**

- Half gallon portable sprayer, lightweight and easy to use
- » 2830570



**GREASE GUN**

- Comfort grip handle and heavy-duty follower spring for high pressure applications and easy priming
- » 414 mL • 2830569
- FOR 414 mL ALL-SEASON & U-JOINT



**GREASE GUN**

- Enables easy application of grease
- » 88.7 mL • 2871312
- FOR 88.7 mL ALL-SEASON & U-JOINT



**FLEX SPOUT**

- Fits all Polaris quart, gallon and 2.5 gallon bottles
- » 2871285



**PUMP**

- Fits 1 and 2.5 gallon bottles
- » 2870465



**FLUID SYRINGE**

- Easily add and remove fluid from your vehicle
- » 2830553



**2D BATTERY-OPERATED SIPHON PUMP**

- Liquid transfer pumps 5-6 quarts/min suctioning power
- » 2830513



**POLARIS HEAVY-DUTY SCRUBBER WIPES**

- » 90 CT • 2830441



**POLARIS SHOP TOWELS**

- » 200 CT WITH DISPENSER (SHOWN) 2830402
- » 200 CT REFILL • 2830403
- » 64 CT REFILL • 2830440



**FLEXIBLE CLUTCH COVER TOOL**

- The perfect tool for hard to reach CVT cover bolts
- » 2830572



**OIL FILTER WRENCH**

- Remove Polaris ORV oil filters with ease
- » 2830550



**FLUID TRAY**

- Holds up to 8 quarts of fluid
- » 2830551



**POLARIS MAGNETIC PARTS TRAY**

- » SILVER • 2830432

# BATTERY CHARGERS



**NOCO BATTERY CHARGER - 1 AMP**

- Ensure your battery is charged with the NOCO Battery Charger 1 Amp
- Includes Boost Eyelet Cable with X-Connector Adapter (2830546)
- » 2830567



**NOCO BATTERY CHARGER - 2 AMP**

- Ensure your battery is charged with the NOCO Battery Charger 2 Amp
- Includes Boost Eyelet Cable with X-Connector Adapter (2830546)
- » 2830568



**1,000 AMP ULTRASAFE LITHIUM JUMP PACK**

- Delivers 1,000 amps for jump starting a dead battery in seconds
- » 2830547



**JUMP PACK PROTECTION CASE**

- Lightweight, durable and rugged custom exterior
- » 2830548



# HD HEAVY DUTY PARTS

All Polaris parts are developed and tested to help you get the most out of your ride. We're taking the passion of our riders, workers and outdoor enthusiasts to the next level with HD Parts.

Engineered and designed for:

- Greater durability
- Enhanced performance
- Greater wear and tear capabilities
- All weather conditions

## OIL FILTERS

The advanced synthetic material built into these filters offers the highest debris holding capacity, maintains oil flow and maximizes performance.

OE	HD HEAVY DUTY PARTS
2520799	2522485
2540086	2522498

## WHEEL BEARINGS

Fully sealed for added protection against intrusions. Made of a higher grade steel for extended life in extreme conditions.

LOCATION	OE	HD HEAVY DUTY PARTS
FRONT WHEEL BEARINGS	3514822	3515090
	3514634	3515088
REAR WHEEL BEARINGS	3514917	3515087

## WHEELS & TIRES

Class leading durability for off-road performance and traction for confident driving in extreme conditions.

- » 1524022-458 • HD WHEEL - 14x7
- » 5457498-458 • HD WHEEL CENTER CAP
- » 5415756 • PRO ARMOR XD-K FRONT
- » 5415757 • PRO ARMOR XD-K REAR

## DRIVE BELTS

The enhanced rubber material compound in these belts keep them cool in extreme heat, while our patented cord treatment process maximizes the transfer of horsepower to the ground for those customers hauling heavy loads.

OE	HD HEAVY DUTY PARTS
3211149	3212326
3211077	3212328
3211113	3212332
3211160	3212331

## BUSHINGS

The advanced material compound of the bushings enables tighter tolerances to reduce overall wear on the system, while the superior triple lip sealing prevents intrusion of the elements.

LOCATION	OE	HD HEAVY DUTY PARTS
FRONT UPPER BUSHINGS	5439874	1543367
FRONT LOWER BUSHINGS	5439874	1543367
	5436973	1543326
REAR UPPER BUSHINGS	5439874	1543367
	5438895	1543326
REAR LOWER BUSHINGS	5439874	1543367
	5436973	1543326

## NEW CV BOOT KIT

TPE rubber compound for maximum puncture and tear resistance, includes (1) boot, grease and clamp to replace OE stock part. Provides increased durability for riding in extreme conditions.

OE	HD HEAVY DUTY PARTS
2204102	2209922
3236165	2209923

## BRAKE PADS

Engineered to provide longer life and better stopping power while riding in extreme conditions.

LOCATION	OE	HD HEAVY DUTY PARTS
FRONT	2205949	2208933
FRONT/REAR	2202413	2208934
	2202412	2208935

## BUSHING KITS

Easily update the entire front and rear suspension.

- » 2830562 (SHOWN)  
570 EFI '16-'20, 570 EFI X2 '16-'20,  
570 EFI TOURING '16-'20,  
570 EPS UTILITY '20,  
450 HO '16-'20, 450 UTILITY '20
- » 2830563  
570 SP '16-'19, 570 PREMIUM '19,  
570 SP TOURING '16-'20

Claims made based off testing and performance of Polaris HD Parts against standard OEM parts made by Polaris and competitor brands under normal use.

For more information regarding Polaris HD parts including vehicle compatibility, installation and maintenance, please contact your authorized Polaris ORV dealer.

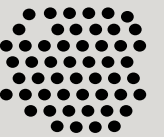

SAND



MUD



WATER



EXTREME COLD



EXTREME HEAT UP TO 54° C



HEAVY PAYLOADS



EXTENDED LIFE

PARTS & GARAGE

MAINTENANCE

OIL & LUBRICANTS

MAINTENANCE FLUIDS

GARAGE ACCESSORIES & BATTERY CHARGERS

HD PARTS

SERVICE PARTS

TIRE SEALANT & TRAILERING

POLARIS POWER

EXTENDED LIFE



# SERVICE PARTS

Polaris Engineered service parts deliver unmatched performance and fit for your off-road vehicle.

All service parts are engineered specifically for your machine. Which means everything is designed, tested and perfected to maximize the life of your ride. Getting Polaris Engineered parts is a decision that pays off in the long run, because it ensures there is a long run.



**VISIT YOUR POLARIS DEALER TO SHOP FOR SERVICE PARTS.**

**OVER  
100,000  
PARTS  
AVAILABLE!**



# FOR THE LIFE OF YOUR RIDE

Maintenance is the key to keeping your Polaris off-road vehicle performing at its peak. Items like belts, lubricants, and batteries represent only a few of these critical items engineered specifically by Polaris.



## POLARIS ENGINEERED DRIVE BELTS

### TESTED, PERFECTED

We test each belt on the intended vehicle – we don't just try to make an existing belt “just work”.  
– Amery Kuhl, Polaris CVT System Engineer

#### OUR INVESTMENT

- 32,187 km of field testing
- Thousands of dyno hours
- 18+ months of development (3,000+ design hours) per belt
- 1,200+ vehicle validation hours
- Collaboration with powertrain & clutch engineers

#### YOUR ADVANTAGE

- No clutch recalibration
- Less wear & tear due to heat
- Ensure maximum performance of your vehicle
- More time out riding, less time wrenching

**OUR INVESTMENTS ENSURE POLARIS BELTS  
OUTPERFORM YOUR EXPECTATIONS.**



# CV BOOT REPAIR KIT\*

FIX ON THE GO | TEMPORARY COVERAGE

- A quick trail-side fix to increase trail time
- The flexible and durable boot material expands over a cone tool for CV boot repairs, without disassembling CV axles
- Universal fit – works as a temporary fix for most powersports axles
- All components fit inside the cone, and a cover is provided for compact durable storage
- Easily fits in a cargo box, attached to the roll cage, in the glovebox or many other storage locations



Items shown are contained inside cone

## ATV CV BOOT REPAIR KIT

Kit includes the following items:

- (1) Expandable CV Boot
- (1) Reusable Cone Tool
- (2) CV Boot Clamps
- (1) Tube of Silicone Lube
- (1) Grease Packet
- (1) Cone Cover

» 2830528

## ATV TRAIL BOOT ONLY

» 2830529

## UTV

- » CV REPAIR KIT 2830526
- » TRAIL BOOT ONLY 2830527

### HOW TO INSTALL

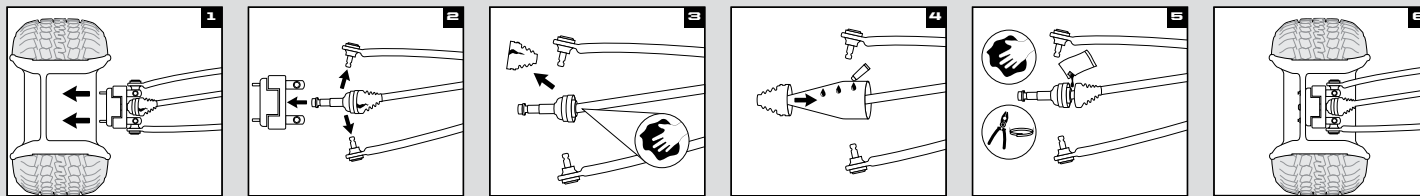

1. Remove wheel and axle nut.
2. Remove brake caliper, hub, tie rod and upper and lower ball joints.
3. Remove old boot and clean joint.
4. Spread silicone lube on entire cone tool. Slide boot over cone tool, large end first. See package for outer boot instructions.
5. Empty the bag of grease into the CV joint/boot, clean sealing points and install clamps.
6. Reassemble tie rod, ball joints, brake caliper, axle nut, tire and wheel.

Refer to your service manual for further instructions and torque specifications.  
\*Designed for temporary CV boot repair. Purchase the OEM CV Boot for a permanent repair.

# TIRE SEALANT



Once a leak occurs, the tire sealant rushes out of the tire and quickly creates a permanent solid plug.

The plug maintains the pressure of the tire so you can continue your ride.

## HOW IT WORKS

Tire sealant remains liquefied inside the tire until a leak develops in the tire or wheel.

### HOW MUCH TIRE SEALANT DO YOU NEED?

$$\begin{array}{r} \text{TIRE HEIGHT (IN.)} \times \text{TIRE WIDTH (IN.)} / 5 = \text{LITERS REQUIRED PER TIRE} \\ | \qquad \qquad \qquad | \qquad \qquad \qquad | \\ 27" \times 10" / 5 = 1.6 \text{ L} \end{array}$$

### PREMIUM TIRE SEALANT

- Instantly seals and repairs rim, bead leaks and punctures up to 0.64 cm on standard tires and 1.9 cm on heavy ply tires
- Helps maintain air pressure for the life of the tire
- Helps seal the tire bead against the wheel
- 100% water soluble for easy cleanup
- Will not rust, corrode or pit wheels
- Creates permanent repair
- Remains fluid and effective in temperatures down to -43° C
- Easily installed through existing tire valve stem with valve core removed

- » 946 mL • 2830484
- » 3.8 L • 2830485
- » 19 L • 2830486
- » 19 L, PUMP • 2830487

- » 208 L • 2830489
- » 1041 L • 2830488

# BRING IT EVERYWHERE

## TRAILERING



### CALIBER RAMP PRO

- Designed for ATVs and UTVs up to 127 cm wide
  - Integrated grip glides for ultimate traction
  - Folding sides for easy transportation and storing
- » 132 cm x 229 cm • 2884576



### ALUMINUM ARCHED LOADING RAMPS

- Capacity for up to 1,361 kg
- » 193 cm x 30.5 cm • 907 kg • 2875384  
» 224 cm x 30.5 cm • 1,361 kg • 2875386



### LIGHTWEIGHT TRI-FOLD RAMPS

- Ramp folds up for transport
  - Capacity for up to 680.7 kg
  - Safety straps included
- » 183 cm x 130 cm • 2875385  
» 208 cm x 130 cm • 2875860

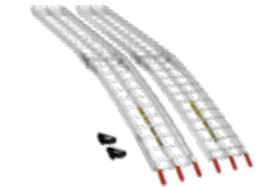

### FOLDING ALUMINUM ARCHED RAMPS

- Ramp folds up for transport
  - Up to 680 kg total capacity, 340 kg per individual ramp
  - Safety straps included
- » 224 cm x 30.5 cm • 2875387

## HITCHES

### 3:1 HITCHES VERSATILE 3 IN 1 FUNCTIONALITY

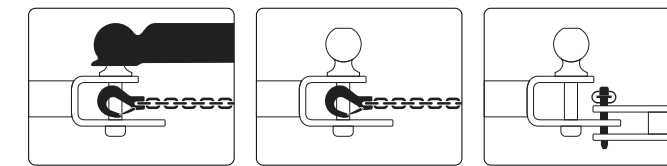

- BALL**
  - HOOK**
  - PIN**
- Ball, hook and pin design
  - Durable, rust resistant steel with black powdercoated finish
  - Removable ball
  - HD 1.6 cm pin and clip



### HITCH WITH 5 cm BALL

- » 5 cm x 5 cm RECEIVER 2830522
- » 3 cm x 3 cm RECEIVER 2830523



### 4.8 cm BALL

- 4.8 cm replacement ball for hitch
  - Designed to work with 3:1 Hitch
- » 2830524



### RECEIVER HITCH

- » 5 cm RECEIVER TONGUE 2875320



### TRAILER BALL AND SHANK

- » 4.8 cm BALL • 2877602
- » 5 cm BALL • 2877603

## COVERS

### TRAILERABLE COVER

- » 2876614  
SPORTSMAN 450/570,  
SPORTSMAN 850/1000  
REPLACEMENT STRAP 2871912

- » 2877999  
ALL SPORTSMAN TOURING  
REPLACEMENT STRAP 2871912





# POLARIS POWER

FOR THE WORKERS, PLAYERS AND SAVE-THE-DAYERS.

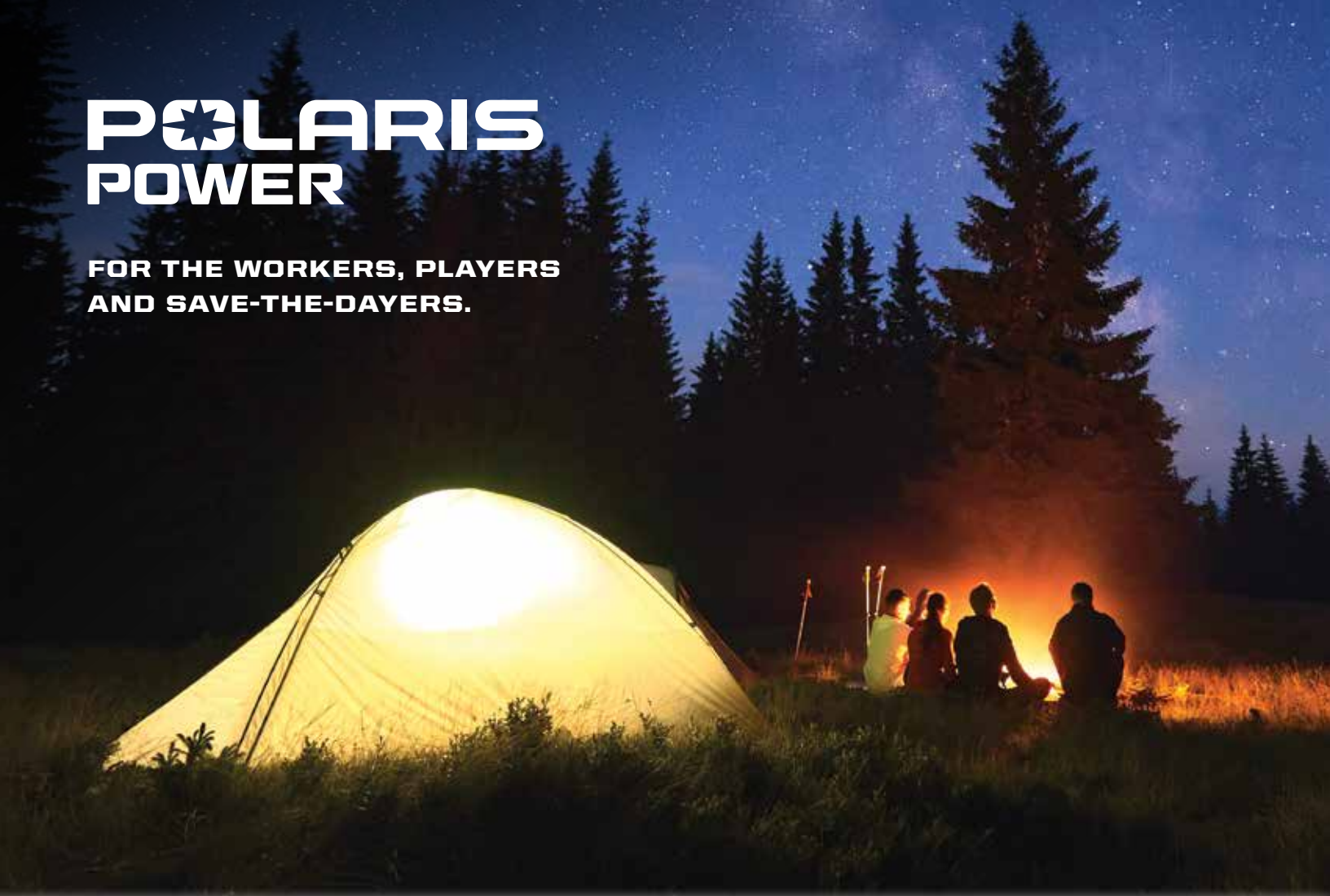

## THE POWER TO EMPOWER

At Polaris Power, we are committed to powering more. We proudly donate 3% of our profits by providing portable power to areas affected by natural disasters and the organizations providing relief in North America.



### P2000i

Inverter Generator

2830532

<b>1600</b> Running Watts	<b>2000</b> Starting Watts	<b>16.7</b> Max Amps at 120V	<b>7.6</b> Run Time at 25% Load w/ Smart Throttle (hrs)	<b>62</b> Noise Level at 25% Load (dBA)
------------------------------	-------------------------------	---------------------------------	--	--

#### FEATURES



Extension Cord Management



Multi Functional Digital Display



Illuminated Control Panel



Multi Handle Design



Parallel Capable

#### BEST USED FOR



Tailgating



Off-Grid



Camping



#### ACCESSORIES

2830536  
2830541

INVERTER PARALLEL KIT  
ALL WEATHER COVER

2884866  
2879383

HIGH ALTITUDE MODIFICATION KIT  
GENERATOR OIL

Read, understand and follow your owner's manual. Never operate a generator indoors. Generator exhaust contains carbon monoxide vapors and exposure can result in severe injury or death. Gasoline is highly flammable and explosive under certain conditions. Always use extreme care whenever handling gasoline.





**NEW**  
**P2500iEBT\***  
Inverter Generator 2830537

<b>2000</b> Running Watts	<b>2500</b> Starting Watts	<b>17</b> Max Amps at 120V	<b>8</b> Run Time at 25% Load w/ Smart Throttle (hrs)	<b>65</b> Noise Level at 25% Load (dBA)
------------------------------	-------------------------------	-------------------------------	--	--

**FEATURES**



Polaris Mobile App Compatible

Digital Fuel Gauge



Carbon Monoxide Detection & Auto Shut Off

Electric Start with Electric Choke



Parallel Capable

**BEST USED FOR**



Camping



Tailgating



Off-Grid



ACCESSORIES 2830536 INVERTER PARALLEL KIT  
2830540 ALL WEATHER COVER

2889540 HIGH ALTITUDE MODIFICATION KIT  
2879383 GENERATOR OIL

\*Check with your local dealer for availability.

**P3200iE**  
Inverter Generator 2830533

<b>2800</b> Running Watts	<b>3200</b> Starting Watts	<b>23.3</b> Max Amps at 120V	<b>10.1</b> Run Time at 25% Load w/ Smart Throttle (hrs)	<b>67</b> Noise Level at 25% Load (dBA)
------------------------------	-------------------------------	---------------------------------	---	--

**FEATURES**



Key Fob Remote Start

Multi Functional Digital Display



Fuel Gauge

Extension Cord Management



Parallel Capable

**BEST USED FOR**



Camping



One Room Backup



DIY Remodeling



ACCESSORIES 2830536 INVERTER PARALLEL KIT  
2830541 ALL WEATHER COVER

2884866 HIGH ALTITUDE MODIFICATION KIT  
2879383 GENERATOR OIL

Read, understand and follow your owner's manual. Never operate a generator indoors. Generator exhaust contains carbon monoxide vapors and exposure can result in severe injury or death. Gasoline is highly flammable and explosive under certain conditions. Always use extreme care whenever handling gasoline.





## P5500 / P6500

2830534 / 2830535  
Open Frame Generator

<b>5000 / 6000</b> Running Watts (P5500 / P6500)	<b>5500 / 6500</b> Starting Watts (P5500 / P6500)	<b>20/30</b> Max Amps at 120/240V	<b>5</b> Run Time (hrs)	<b>75</b> Noise Level (dBA)
--	---	---	-------------------------------	-----------------------------------

### FEATURES



Extension Cord Management



Fuel Gauge



Electric Start



Rough Terrain Wheel

### BEST USED FOR



Construction



Home Backup



RV'ing



- ACCESSORIES**
- 2830542 ALL WEATHER COVER
  - 2884867 HIGH ALTITUDE MODIFICATION KIT

2879383 GENERATOR OIL

Read, understand and follow your owner's manual. Never operate a generator indoors. Generator exhaust contains carbon monoxide vapors and exposure can result in severe injury or death. Gasoline is highly flammable and explosive under certain conditions. Always use extreme care whenever handling gasoline.

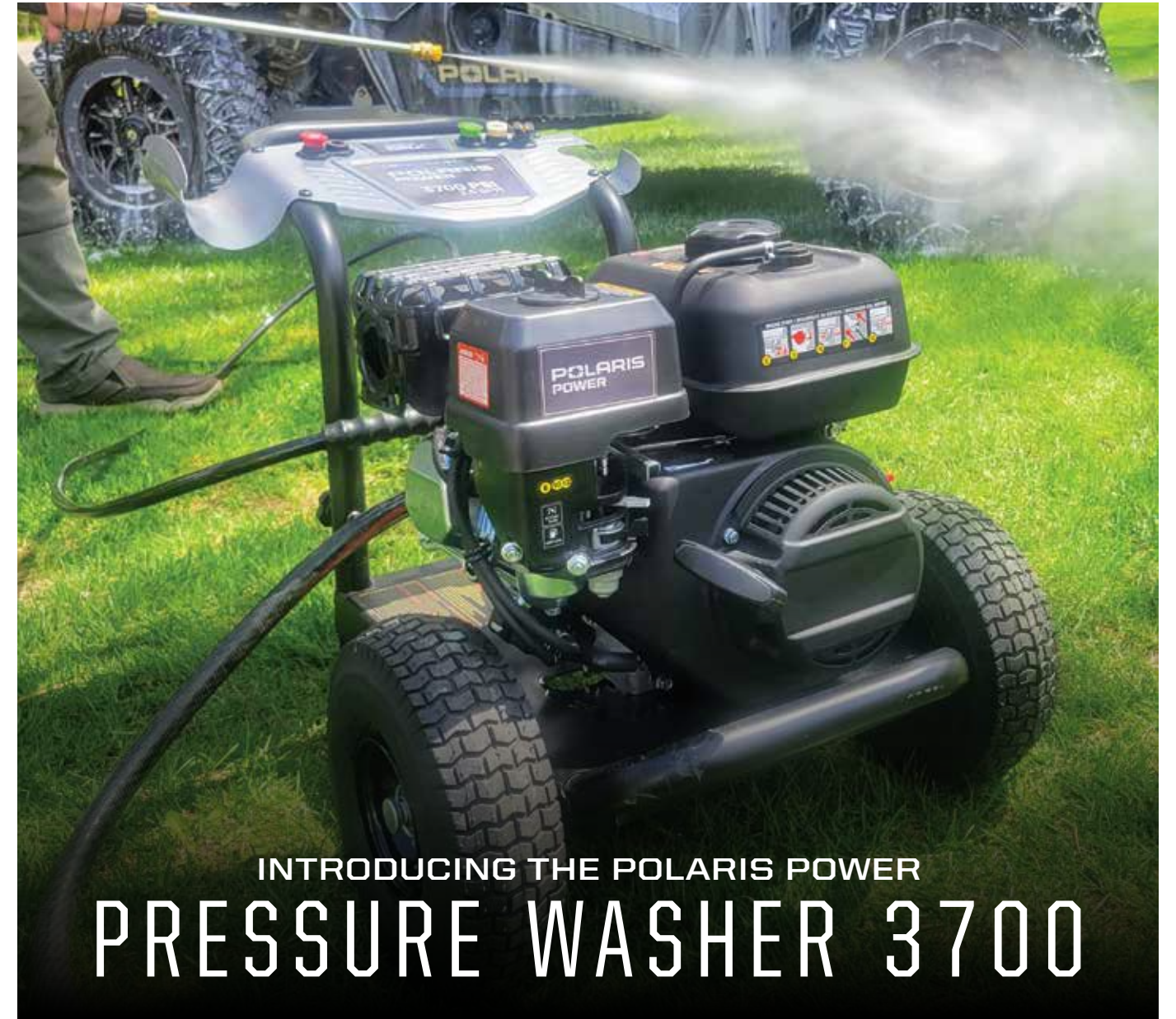

## INTRODUCING THE POLARIS POWER PRESSURE WASHER 3700

### NEW PRESSURE WASHER 3700

- 3700 PSI at 2.5 GPM
- Simpson Pro-Axial Cam Pump
- CRX 4-stroke 225cc OHV engine
- Low-oil shut-down system
- 10" pneumatic tires
- Heavy-duty steel engine plate
- 1.25" tubular construction
- Professional spray gun
- 50' Morflex® hose

» 2830573

### PRESSURE WASHER ACCESSORIES



#### NEW EXTENSION HOSE

- Designed to be highly flexible and kink resistant
- This cold water hose is equipped with standard M22 threaded connections, a dual o-ring and polyurethane outer jacket that is non-marring and abrasion-resistant for improved durability

» 2830577



#### NEW TURBO NOZZLE

- 3700 PSI .25" QC turbo nozzle delivers a strong jet of oscillating water that cleans faster than standard nozzles
- Made for reliability and durability, this nozzle is easy to use and great at cleaning hard to remove dirt and debris

» 2830579





# APPAREL

**GEAR UP FOR YOUR ADVENTURE.** Adventure invites you to gear up and make the most out of every moment, through the thrills, the fun and the memories. Live boldly on and off the trail with Polaris apparel and represent the brand that helps you get outside, stay outside, and THINK OUTSIDE.

APPAREL

JERSEYS & GLOVES  
& HEATED APPAREL

HELMETS & GOGGLES

MEN'S APPAREL

BALL CAPS

CAMO APPAREL

WOMEN'S APPAREL

HOME  
& COLLECTIBLES



# JERSEYS & GLOVES



## OFF-ROAD RIDING JERSEYS

Mesh ventilated panels for maximum airflow  
Elastic sleeves with non-restrictive cuffs



- |   |   |  |  |  |
|---|---|--|--|--|
| <b>BLACK</b><br>JERSEY   S-3XL   2862718<br>GLOVES   S-3XL   2862726<br>YOUTH JERSEY   S-XL   2862723 | <b>ORANGE</b><br>JERSEY   S-3XL   2862719<br>GLOVES   S-3XL   2862729 | <b>TEAL</b><br>JERSEY   S-3XL   2862720<br>GLOVES   S-3XL   2862727<br>YOUTH JERSEY   S-XL   2862724 | <b>GREEN</b><br>JERSEY   S-3XL   2862721<br>GLOVES   S-3XL   2862730 | <b>BLUE</b><br>JERSEY   S-3XL   2862722<br>GLOVES   S-3XL   2862728<br>YOUTH JERSEY   S-XL   2862725 |
|---|---|--|--|--|

## OFF-ROAD RIDING GLOVES

Adjustable wrist closure for a custom fit  
Silicon finger grips and neoprene knuckle protection



## TEKVEST® FREESTYLE

Black | S-3XL | 2862577

# HEATED APPAREL

Keep warm even on the coldest days with Polaris Heated Apparel. By keeping the heat close to your body, you can stay out for a longer, more comfortable ride. The Polaris Heated Apparel lineup includes the Heated Vest, Heated Base Layers and a Heated Glove Liner for both men and women. Easily control your heat setting with the touch of a button.



**WOMEN'S**  
Black | S-3XL | 2833036

**MEN'S**  
Black | S-3XL | 2833022



Black | S-3XL | 2833044

## NEW HEATED VESTS

WARMTH WITH THE TOUCH OF A BUTTON

- Perfect for any outdoor activity
- Down-proof machine washable material with 160g of insulation for warmth with or without the heater turned on
- Powered by a small rechargeable battery (included) that can also be used to charge a cellphone; battery not machine washable, remove prior to washing
- Easily adjust between four heat settings for changing weather conditions with built-in buttons

## NEW HEATED GLOVE LINER

KEEP YOUR HANDS WARM ON FROSTY DAYS

- Designed to fit under all Polaris riding gloves for an extra layer of warmth to keep you out riding longer
- Easily adjust your heat level by pressing a button on the bottom part of the glove



**WOMEN'S**  
Top | S-3XL | 2833033  
Bottom | S-3XL | 2833034

**MEN'S**  
Top | S-3XL | 2833031  
Bottom | S-3XL | 2833032

## NEW HEATED BASE LAYERS

ADJUSTABLE HEAT CLOSE TO YOUR BODY, MAXIMUM COMFORT IN CHANGING CONDITIONS

- Intended for use as a base layer
- Features lightweight, moisture-wicking fabric to give you the most comfortable layering to wear on all of your cold weather adventures, on or off the trail
- Includes multiple heat panels for evenly distributed heat for maximum warmth and comfort
- Powered by a small rechargeable battery (included) that can be used to charge a cellphone; battery not machine washable, remove prior to washing
- Easily adjust between four heat settings for changing weather conditions with built-in buttons



# HELMETS

**FOR**  
**POLARIS**

**NEW**  
RED  
XS-4XL  
2833054



# ALTITUDE

## 509 ALTITUDE 2.0 HELMET

LIGHTWEIGHT DESIGN, PERFORMANCE-INFUSED STYLE AND GOPRO MOUNTING CAPABILITY

### SHELL

- Thermoplastic poly alloy outer shell

### WEIGHT

- Composite as low as 1,200g
- Carbon fiber as low as 1,150g

### FEATURES

- Strong, lightweight construction of carbon fiber or composite
- Superior fit for all-day comfort
- Pro Series breath box for complete protection, removable for optimal air flow
- One-piece eyeport creates draft-free seal with 509 goggles
- Magnetic Fidlock™ chin-strap technology and integrated GOPRO™ mount
- DOT- and ECE 22.05-approved

**FIDLOCK**



**NEW**  
RADIANT GREEN  
XS-4XL  
2833051



BLACK  
XS-4XL  
2861469



CARBON FIBER  
BLACK/LIME  
XS-4XL  
2861473

**FOR**  
**POLARIS**

**NEW**  
PINK  
XS-4XL  
2833050



# TACTICAL

## TACTICAL 2.0 HELMET

COMBINES STYLE WITH VERSATILITY FOR ULTIMATE COMFORT AND CONTROL

### SHELL

- Shock-resistant, injection-molded thermoplastic

### FEATURES

- Innovative Venturi Vent pulls moist air from helmet without cold wind coming in
- Eyeport seal is co-integrated with the removable breath box and creates a draft-free seal with 509 goggles and a clear field of view
- Magnetic Fidlock™ chin-strap technology
- DOT- and ECE 22.06-approved

**FIDLOCK**



MATTE BLACK  
XS-4XL  
2862468



GRAY  
XS-4XL  
2862469



RED/BLACK  
XS-4XL  
2862467



ORANGE  
XS-4XL  
2862471



**NEW**  
BLUE  
XS-2XL  
2833143

# TENACITY

## TENACITY 4.0 HELMET

COMBINATION OF MODERN STYLE AND PREMIUM PROTECTION WITH INCREDIBLE VALUE

### SHELL

- Shock-resistant, injection-molded thermoplastic

### WEIGHT

- 1,500g

### FEATURES

- Through-flow, full-helmet ventilation
- ProClip quick release chin strap allows you to fasten the chin strap in seconds
- Removable breath box and removable, washable liner
- Tool-less adjustable roost shield
- DOT- and ECE 22.05-approved



**NEW**  
RADIANT GREEN  
XS-2XL  
2833142



BLACK  
XS-2XL  
2861557



BLACK/GRAY  
XS-2XL  
2861558



BLACK/LIME  
XS-2XL  
2861559



WHITE/RED  
XS-2XL  
2861561



PINK  
XS-2XL  
2861562

# GOGGLES



ORANGE  
2862561



LIME  
2862559

## 509 KINGPIN OFF-ROAD GOGGLE

PREMIUM MATERIALS, ATTRACTIVE PRICE

### FEATURES

- Oversized spherical lens delivers optimal peripheral vision
- Metal tear-off posts provide strength and durability
- Quick-change technology allows you to run the best lens tint for conditions



BLUE  
2862562



STEALTH  
2862560

## 509 MX6 OFF-ROAD GOGGLE

SUPER WIDE FIELD OF VIEW, ENGINEERED FOR DIRT

### FEATURES

- PC outer lens with anti-scratch coating, and internal anti-fog coating
- Outriggers with latch system for quick lens change
- 45mm strap with silicone to hold strap in place



BLACK  
2862557



RED/BLACK  
2862558





**RED/GRAY**  
S-3XL | 2833029

**BLACK**  
S-3XL | 2861432

## FORCE PUFFER JACKET

PACKABLE JACKET OFFERS LIGHTWEIGHT PROTECTION, IDEAL FOR ANY ACTIVITY

- 140g 3M<sup>®</sup> Thinsulate<sup>®</sup>
- Plenty of storage with two external hand pockets and one internal media pocket
- Rugged YKK zippers
- Great for travel, compacts into pocket



**ORANGE**  
S-3XL | 2833027

**BLUE**  
S-3XL | 2833028

**BLACK**  
S-3XL | 2861434

## SOFTSHELL JACKET

VERSATILE LIGHTWEIGHT JACKET THAT'S PERFECT FOR EVERYDAY WEAR

- Casual jacket armed with rugged and warm features for everyday wear
- Superior DWR prevents precipitation from saturating the jacket's exterior
- Lined with soft fleece for warmth
- Removable hood and underarm venting, three external pockets and one internal chest pocket



**BLACK**  
S-3XL | 2862569

**NAVY**  
S-3XL | 2862570

## WORK VEST

RUGGED AND DURABLE VEST THAT'S IDEAL AS AN OUTDOOR LAYER

- Made of durable nylon fabric to make it the ideal vest for work
- 80g 3M<sup>®</sup> Thinsulate<sup>®</sup> Insulation provides great warmth
- Vest comes with plenty of pockets to store your valuables



**GRAY**  
S-3XL | 2860863

**BLACK**  
S-3XL | 2861608

## WORK JACKET

WARM AND RUGGED JACKET THAT'S TOUGH FOR WORK AND STYLISH FOR PLAY

- Coated with Durable Water Repellency (DWR) to provide water-resistance
- Built in action back for increased range of motion
- 80g 3M<sup>®</sup> Thinsulate<sup>®</sup> for added warmth with brushed flannel trim
- One inner and four outer pockets for storage

## REVOLVE VEST

REVERSIBLE

DURABLE AND WARM REVERSIBLE VEST OFFERS TWO STYLES IN ONE

- Durable windbreak outer fabric helps protect from the elements
- 140g 3M<sup>®</sup> Thinsulate<sup>®</sup> insulation keeps you warm in cold weather
- Reversible vest offers two unique styles in one



**RED**  
S-3XL | 2833030

**BLACK/GRAY**  
S-3XL | 2862565

## WINDBREAKER JACKET

LIGHTWEIGHT, WINDPROOF JACKET THAT PROVIDES PROTECTION WHILE RIDING

- 100% polyester windproof fabric
- Lightweight construction makes it easy to pack
- Three external pockets allow for maximum storage



**BLACK**  
S-3XL | 2861541

## FLANNEL JACKET

SHERPA FLEECE LINED JACKET DELIVERS EXCEPTIONAL WARMTH AND COMFORT

- Warm sherpa lined fleece material
- Insulation to keep you warm
- Plenty of storage for your valuables



**CHARCOAL**  
S-3XL | 2860865

**BRONZE**  
S-3XL | 2860864







**STAMP HOODIE**

**NEW** Green | S-3XL | 2833061  
 Black | S-3XL | 2862484  
 Navy | S-3XL | 2861500



**CREW SWEATSHIRT**

**NEW** Gray | S-3XL | 2833067  
 Black | S-3XL | 2862488  
 Navy | S-3XL | 2861497



**ICON HOODIE**

**NEW** Black/Red | S-3XL | 2833065  
 Gray | S-3XL | 2862487  
 Green | S-3XL | 2861495



**TITAN MID-LAYER**

**NEW** Red | S-3XL | 2833026  
 Black | S-3XL | 2862568  
 Blue/Orange | S-3XL | 2862567



**NORTHSTAR MID-LAYER**

**NEW** Black/Lime | S-3XL | 2833024  
 Tan | S-3XL | 2862450



**JOURNEY HOODIE**

**NEW** Navy | S-3XL | 2833066  
 Black | S-3XL | 2862489



**ICON LONG SLEEVE**

**NEW** Lime | S-3XL | 2833083  
 Gray/Red | S-3XL | 2862505  
 Black | S-3XL | 2861584



**DASH LONG SLEEVE**

**NEW** Black/Red | S-3XL | 2833082  
 Navy | S-3XL | 2861583  
 Black | S-3XL | 2861582



**PERFORMANCE LONG SLEEVE**

**NEW** Gray | S-3XL | 2833168  
 Black | S-3XL | 2862507



**NEW**  
**STAPLE HOODIE**

Black | S-3XL | 2833068  
 Navy | S-3XL | 2833069  
 Green | S-3XL | 2833070



**TECH FULL-ZIP HOODIE**

**NEW** Red | S-3XL | 2833064  
 Gray | S-3XL | 2861493



**ROGUE HOODIE**

**NEW** Black | S-3XL | 2833062  
**NEW** Navy | S-3XL | 2833063  
 Gray | S-3XL | 2862485



**ICON TEE**

**NEW** Lime | S-3XL | 2833079  
 Green | S-3XL | 2862501  
 Black | S-3XL | 2861570



**NEW**  
**GRAPHIC TEE**

Dark Gray | S-3XL | 2833086  
 Forest Green | S-3XL | 2833087



**FLAG TEE**

Navy | S-3XL | 2862500  
 White | S-3XL | 2862582



# BALL CAPS



**NEW**  
LEATHER PATCH HAT

Black | One Size | 2833129  
Gray | One Size | 2833130



**NEW**  
STAPLE CAP

Black | One Size | 2833127  
Navy | One Size | 2833128



HIGHLAND CAP

**NEW** Navy | One Size | 2833126  
Tan | One Size | 2860893  
Gray | One Size | 2862544

# CAMO APPAREL



CAMO SOFTSHELL JACKET

Camo | S-3XL | 2861543



MEN'S CAMO REVOLVE VEST

Camo | S-3XL | 2862572



MEN'S CAMO PURSUIT HOODIE

Camo | S-3XL | 2862494



WOMEN'S CAMO PURSUIT HOODIE

Camo | S-3XL | 2862517



**NEW**  
PURSUIT HOODIE

Black | S-3XL | 2833076  
Green | S-3XL | 2833077



CAMO NECK GAITER

Camo | One Size | 2861948



STEALTH CAMO HAT

Camo | One Size | 2861527



HUNTER ORANGE HAT

Orange | S/M | 2860892  
Orange | L/XL | 2862545



HUNTER ORANGE BEANIE

Orange | One Size | 2862595

APPAREL

JERSEYS & GLOVES  
& HEATED APPAREL

HELMETS & GOGGLES

MEN'S APPAREL

BALL CAPS

CAMO APPAREL

WOMEN'S APPAREL

HOME  
& COLLECTIBLES





**NEW**  
**RADIANT GREEN** | S-3XL | 2833039  
**BLACK** | S-3XL | 2862457



**NEW** **BLACK** | S-3XL | 2833041  
**NEW** **RADIANT GREEN** | S-3XL | 2833040  
**BLUE** | S-3XL | 2862460

## REVOLVE VEST

DURABLE AND WARM REVERSIBLE VEST OFFERS TWO STYLES IN ONE

- Durable windbreak outer fabric protects you from the elements
- 140g 3M® Thinsulate® insulation keeps you warm in cold weather
- Reversible for two unique styles in one

## SOFTSHELL JACKET

VERSATILE LIGHTWEIGHT JACKET THAT'S PERFECT FOR EVERYDAY WEAR

- Casual jacket armed with rugged and warm features
- Superior DWR prevents precipitation from saturating the jacket's exterior
- Lined with 280g of soft fleece for warmth
- Removable hood and underarm venting
- Three external pockets and one internal chest pocket



**BLACK** | S-3XL | 2861433



**BLACK** | S-3XL | 2862563  
**BLUE** | S-3XL | 2862564



**NEW** **RADIANT GREEN** | S-3XL | 2833042  
**BLACK/GRAY** | S-3XL | 2862458

## FORCE PUFFER JACKET

PACKABLE JACKET OFFERS LIGHTWEIGHT PROTECTION AND INCREDIBLE WARMTH

- 140g 3M® Thinsulate®
- Two external hand pockets, one internal media pocket
- Rugged YKK® zippers
- Compactable into travel pocket

## WORK JACKET

WARM AND RUGGED JACKET THAT'S TOUGH FOR WORK AND STYLISH FOR PLAY

- 100% nylon shell is coated with DWR to help keep you dry
- 80g 3M® Thinsulate® for added warmth with brushed flannel trim
- Built-in action back for increased range of motion
- One inner and four outer pockets for storage

## TITAN MID-LAYER

EXTREMELY WARM YET BREATHABLE MID-LAYER, PERFECT FOR RIDING

- 319g Polartec® Thermal Pro® Rib Sweater provides great warmth
- Breathable material moves sweat to the outer surface
- Nylon overlay is comfortable and light



**NEW**  
**STAPLE HOODIE**  
 Black | S-3XL | 2833095  
 Gray | S-3XL | 2833096



**NEW**  
**JOURNEY HOODIE**  
 Radiant Green | S-3XL | 2833098  
 Black | S-3XL | 2862515  
 Blue | S-3XL | 2862516



**NEW**  
**TECH FULL-ZIP HOODIE**  
 Black | S-3XL | 2833097  
 Maroon | S-3XL | 2861509  
 Gray | S-3XL | 2861508



**NEW**  
**ICON HOODIE**  
 Gray | S-3XL | 2833099  
 White | S-3XL | 2862512



**NEW**  
**ADVENTURE CREW**  
 Black/Radiant Green | S-3XL | 2833100  
**NEW** Green | S-3XL | 2833101  
 Dusty Rose | S-3XL | 2862513  
 Black | S-3XL | 2862514



**NEW**  
**ADVENTURE LONG SLEEVE**  
 Gray | S-3XL | 2833107  
 Navy | S-3XL | 2833108



**NEW**  
**CORE TANK**  
 Black | S-3XL | 2833161  
 Gray | S-3XL | 2833160



**NEW**  
**FLAG TEE**  
 Gray | S-3XL | 2833163  
 White | S-3XL | 2833162



**NEW**  
**ADVENTURE TEE**  
 Pink | S-3XL | 2833104  
 Black Frost | S-3XL | 2862628  
 Teal | S-3XL | 2862629





**RETRO CLOCK**  
91.4 cm | 2868662



**NEW**  
**POLARIS LED SIGN**  
91.4 cm x 35.6 cm | 2862736



**ALUMINUM SIGN**  
55.9 cm | 2860867



**WOOD SIGN**  
61 cm x 26.7 cm | 2860866



**RETRO GLASSES (SET OF 2)**  
2866265



**12oz CAMPER MUG**  
2861612



**23oz WATER BOTTLE**  
2862685



**WOODEN COASTERS**  
2860869



**15oz CAMPFIRE MUG**  
2861613



**PREMIUM KOOZIE**  
2860829



**LEATHER LOOP KEYCHAIN**  
2861615



**KEYCHAIN**  
2861614



**KICKBACK ROCKER**  
2862626



**FREESTYLE ROCKER**  
2862625



**EASY CHAIR**  
2862627



**QUICK-E-SEAT**  
2862624



**FOLDABLE TABLE**  
2861620



**POP-UP TRASH BIN**  
2861622



**FLASK**  
2860812



**DECK OF CARDS**  
2860816



**HITCH COVER**  
2861623



**LICENSE PLATE HOLDER**  
2862687



**POLARIS PARKING SIGN**  
2869934



**POLARIS FLAG**  
5' x 3' | 2869928



Availability varies by market, check your local dealer for availability. Never transport a loaded firearm. Verify firearm is unloaded prior to mounting. Please refer to local laws and regulations regarding the requirements for the legal transport of firearms.

Warning: Polaris off-road vehicles can be hazardous to operate and are not intended for on-road use. Driver must be at least 16 years old with a valid driver's license to operate. All riders should always wear helmets, eye protection and protective clothing and footwear. Read, understand and follow your owner's manual. Ride within the limits of your own abilities and never engage in stunt or exhibition driving. Never ride under the influence of drugs or alcohol. All riders should take a safety training course. Call 800-342-3764 for additional information.

Unless noted, trademarks are the property of Polaris Industries Inc. 3M® and Thinsulate® are registered trademarks of 3M Company. 509® is a registered trademark of Teton Outfitters, LLC. App Store® is a registered trademark of Apple Inc. BatteryMINDer® is a registered trademark of VDC Electronics Inc. Bluetooth® is a registered trademark of Bluetooth SIG, Inc. Caliber® is a registered trademark of Caliber, Inc. Facebook™ is a service trademark of Facebook, Inc. Fidlock® is a registered trademark of Fidlock GmbH. FOX® is a registered trademark of Fox Factory Inc. Google Play™ and YouTube® are registered trademarks of GOOGLE LLC. GoPro® is a registered trademark of GoPro Inc. Instagram™ is a service trademark of Instagram, LLC. Kolpin® is a registered trademark of Polaris Industries Inc. MORFLEX® is a registered trademark of FNA Group, Inc. NOCO Genius® is a registered trademark of The Noco Company. OGIO® is a registered trademark of Ogio International, Inc. Polartec® is a registered trademark of MMI-IPCO, LLC. RIGID® is a trademark of JST Performance, LLC d/b/a Rigid Industries, LLC. Rockford Fosgate® is a registered trademark of Rockford Corporation. SMART BOARD® is a registered trademark of SMART TECHNOLOGIES ULC UNLIMITED LIABILITY CORPORATION CANADA. TEKVEST® is a registered trademark of 1181676 ONTARIO INC. Tiger Drylac® is a registered trademark of TIGER COATINGS GMBH & CO. KG. Velcro® is a registered trademark of VELCRO BVDA. Twitter™ is a registered trademark of Twitter, Inc. WALKER EVANS RACING® is a registered trademark of Walker Evans Enterprises Incorporated. Yeti® is a registered trademark of Yeti Coolers, LLC. YKK® is a registered trademark of YKK Corporation. Prices, fitment and availability are subject to change at any moment. Copyright © 2022 Polaris Industries Inc. All rights reserved.



# FORGE YOUR OWN PATH



**POLARIS**  
Think Outside

MY23 SPTSMN APP ACC.INTL